

A map of Indiana showing major highways and work zone traffic control guidelines. The map features a network of roads in red, blue, and green, with various markers and labels. The title 'WORK ZONE TRAFFIC CONTROL GUIDELINES' is prominently displayed in the center. The Indiana Department of Transportation logo is positioned in the middle, and the subtitle 'Construction, Traffic, Maintenance and Utility Operations 2024' is at the bottom.

WORK ZONE TRAFFIC CONTROL GUIDELINES



**Construction, Traffic, Maintenance
and Utility Operations 2024**

Introduction	1
Incident Management Situations	1
Traffic Control Devices	1
Signs	2
Spacing of Advance Warning Signs	3
Worksite Added Penalty Signs	4
Worksite Added Penalty Signs	5
Automated Flagger Assistance Devices (AFADs)	8
Portable Signals	8
Channeling Devices	9
Channeling Devices.....	10
Warning Lights	11
Arrow Displays	12
Arrow Display Condition	13
Pavement Markings.....	14
Fundamental Principles	14
Parts of a Traffic Control Zone	15
Taper Length Criteria for Work Zones	16
Buffer Lengths and Flagger Stations.....	17
Supervisor’s Checklist.....	18
Planning the Layout	19
Duration of Work	19
Location of Work	19
Traffic Control Devices Set Up and Take Down	19
What Traffic Control Set-Up Should I Use?.....	20
Curvy and Hilly Locations	20
Nighttime Traffic Control	21
Typical Application Diagrams	23
Definitions of Terms	24

Short Term Stationary (1 to 12 hours) 25

- Work off the Traveled Lanes Includes Paved Shoulder < 8ft..... 25
- Work on Paved Shoulders >8 feet or Parking Lanes..... 26
- Paved Shoulder >8 feet Closed on Divided Roadway..... 27
- Lane Closure on a Two-Lane Road (Two Flagger Operation) 28
- Center Turn Lane Closed 29
- Lane Shift on a Three-Lane Two-Way Road..... 30
- Interior Lane Closure on a Four-Lane Undivided Road..... 31
- Lane Closure on Divided Roadway or One Way Street 32
- Double Lane Closure on Divided Roadway..... 33
- Half Road Closure on Multilane Roadway 34
- Half Road Closure on Multilane Roadway (cont.)..... 35
- Mainline Right Lane Closed, Entrance Ramp Open 36
- Mainline Left Lane Closed, Entrance Ramp Open 37
- Work in Vicinity of Exit Ramp – Right side of Ramp 38
- Work in Vicinity of Exit Ramp – Left side of Ramp 39
- Partial Ramp Closure 40
- Partial Ramp Closure Work in Gore Area 41
- Lane Closure in Advance of an Intersection (Work Area on the Major Road)..... 42
- Lane Closure in Advance of an Intersection (Work Area on the Minor Road)..... 43
- Lane Closure Beyond an Intersection (Work Area on the Major Road)..... 44
- Lane Closure Beyond an Intersection (Work Area on the Minor Road)..... 45
- Lane Closure Beyond an Intersection (cont.)..... 46
- Lane Closure at a Multilane Intersection 47
- Turn Lane Closure at an Intersection..... 48
- Lane Closure on Far Side of Intersection (Speeds of 35 mph or less)..... 49
- Closure in Center of Intersection 50
- Work In a Roundabout 51

Short Duration (Up to 1 hour) 52



Work off the Traveled Lanes (Includes Paved Shoulder < 8ft.)	52
Work on Paved Shoulders or Parking Lane > 8ft.....	53
Work on Paved Shoulder >8 ft. Closed on Divided Roadway	54
Lane Closure on Divided Roadway or One Way Street	55
Lane Closure on a Two-Lane Road (Two Flagger Operation)	56
Temporary Road Closure	57
Lane Closure in Advance of an Intersection (Work Area on the Major Road	58
Lane Closure in Advance of an Intersection (Work Area on the Minor Road).....	59
Lane Closure Beyond an Intersection (Work Area on the Major Road).....	60
Lane Closure Beyond an Intersection (Work Area on the Minor Road).....	61
Lane Closure at Side of Intersection.....	62
Work in Center of Intersection	63
Lane Closure at a Multilane Intersection	64
Turn Lane Closure at an Intersection.....	65
Partial Ramp Closure	66
Partial Ramp Closure Work in Gore Area	67
Mobile Operations	68
Mobile Operations	68
Mobile Operation on Paved Shoulder >8ft. for all Roads	69
Mobile Operation on the Shoulder (cont.)	70
Mobile Operation on a Two-Lane, Two-Way Road	71
Mobile Operation on a Two-Lane, Two-Way Road (cont.)	72
Mobile Operation on a Two-Lane Road Using Flaggers	73
Mobile Operation on a Four-Lane Divided Road	74
Mobile Operation on a Multi-Lane Divided Road	75
Mobile Operation on a Multi-Lane Road (cont.)	76
Flagging Procedures.....	77
Quick Reference Guide	78
Quick Reference Guide (cont.)	79

Acceptable Channelizing Device Usage 80

Acceptable Channelizing Device Usage (cont.)..... 81

Introduction

The purpose of this handbook is to present guidelines for work zone traffic control and to supplement basic work zone safety training. This handbook covers the basic requirements of Part VI of the 2011 Indiana Manual on Uniform Traffic Control Devices (IMUTCD) with particular emphasis on short term worksites. For long term worksites, the IMUTCD and INDOT Standard Drawings should be consulted. These requirements apply to construction, maintenance, traffic, and utility work zones.

This handbook presents information and gives examples of typical traffic control applications for two-lane and multi-lane work zones. This information is intended to illustrate the principles of proper work zone traffic control and recommendations based on INDOT best practices. Part VI of the IMUTCD contains the standards for work zone traffic control.

*The worksite traffic control diagrams in this handbook provide **minimum** requirements. Additional traffic control or protection can be added.*

Incident Management Situations

The immediate response to an emergency situation must by necessity make use of available devices and equipment. Given the opportunity, however, longer term emergencies should be treated in a manner similar to other temporary traffic control worksites.

Traffic Control Devices

The following types of traffic control devices are used in work zone traffic control:

- Signs
- Channelizing Devices
- Warning Lights
- Arrow Displays
- Pavement Markings
- Portable Changeable Message Signs
- Automated Flagger Assistance Devices
- Portable Signals

Signs

Signs used in work zone traffic control are classified as regulatory, guide, or warning. Regulatory signs impose legal restrictions and may not be used without permission from the authority with jurisdiction over the roadway. Traffic regulations on the state highway system **must** be adopted by the District Deputy Commissioner and documented with an Official Action to be enforceable with the exception of Worksite Speed Limits which are established by Indiana Code. See Operations Memorandum [OM 06-01](#) for information on use of this type of speed limit. The District Traffic Engineer should be consulted when an Official Action is needed.

Guide signs commonly show destinations, directions, and distances. Warning signs give notice of conditions along the roadway.

Signs used in operations involving a Trailer-Mounted Attenuator should be mounted on the truck and not the trailer or attenuator to maintain the attenuators crash worthiness.

Spacing of Advance Warning Signs

Table I: Sign Spacing (ft.)					
	25-30 mph	35-40 mph	45-55 mph	Multilane Divided 50 mph or higher	Expressway/ Freeway
A	100	350	500	1000	1000
B	100	350	500	1600	1600
C	100	350	500	2640	2640

Distances shown are approximate. Sign spacing should be adjusted for curves, hills, intersections, driveways, etc., to improve sign visibility.

Warning Signs – Construction, maintenance, traffic, and utility warning signs are used extensively in street and highway work zones. These signs are normally diamond shaped, having a black symbol or message on an orange background. As a general rule, these signs are located on the right-hand side of the street or highway. Normally, the first advance warning sign used is the Added Penalty Sign. (See pages 4 and 5.) Next is the ROAD WORK AHEAD sign. The UTILITY WORK AHEAD or WORKERS sign may be substituted where appropriate. Where signs are used to indicate the end of the work zone, the END ROAD WORK or END UTILITY WORK sign may be used as appropriate.

Size – The standard size for advance warning signs in work zones is generally 48 inches by 48 inches. Where speeds and volumes are moderately low, 35 mph and 2000 AADT, a minimum size of 36 inches by 36 inches may be used (see Part VI of the IMUTCD for specific sign sizes). Sign sizes in contract plans or other agency documents may exceed IMUTCD minimum requirements and shall be followed.

Mounting – Standards for height and lateral clearance of roadside signs are included in Part VI of the IMUTCD. Temporary post-mounted signs should be mounted at a height of at least 7 feet, measured from the bottom of the sign. Signs mounted on Type III barricades which close any part of a road or lane should not cover more than 50% of the top two rails or 33% of the total area of the three rails. **Signs mounted on other portable supports or barricades used solely as a sign support may be at lower heights, but the bottom of the sign shall be not less than 1 foot above the traveled way.**

Worksite Added Penalty Signs



XW2-6

Worksite Added Penalty Sign

Notes:

1. Except as noted in item 2, this sign shall be used when traffic will travel through an active construction zone marked by ROAD WORK AHEAD.
2. Signs are not required for the following types of activities:
 - Where the active construction zone is completely isolated from traffic (i.e., a full road closure with detour or construction along a new alignment).
 - Short duration operations (those lasting less than 1 hour).
 - Operations that will not encroach upon the pavement.
 - Edgeline and centerline painting operations.
3. A single sign should be called for in advance of the first ROAD WORK AHEAD sign for each direction of travel on the mainline(s) of the project.
4. One sign should be placed approximately 500 feet in advance of the first ROAD WORK AHEAD sign in rural areas.
5. One sign should be placed approximately 100 feet in advance of the first ROAD WORK AHEAD sign in urban areas.
6. Signs are not required to be placed on side roads or ramps leading into a construction zone.
7. For Mobile Operations the rectangular sign may be truck mounted on rear-most shadow vehicle.

Worksite Added Penalty Signs



XW2-6a
Added Penalty Sign I



XW2-6b
Added Penalty Sign II

Notes:

1. Signs should be called for when traffic will travel through an active construction zone marked by ROAD WORK AHEAD.
2. Signs are not required for the following types of activities:
 - Where the active construction zone is completely isolated from traffic (i.e., a full road closure with detour or construction along a new alignment).
 - Short duration operations (those lasting less than 1hr.)
 - Operations that will not encroach upon the pavement.
 - Edgeline and centerline painting operations.
3. A single set of signs should be called for in advance of the first ROAD WORK AHEAD sign for each direction of travel on the mainline(s) of the project.
4. For rural areas, sign I should be placed 1000 feet in advance of the first ROAD WORK AHEAD sign and sign II should be 500 feet in advance of the first ROAD WORK AHEAD sign.
5. For urban areas, sign I should be placed 200 feet in advance of the first ROAD WORK AHEAD sign and sign II should be 100 feet in advance of the first ROAD WORK AHEAD sign.
6. Signs are not required to be placed on side roads or ramps leading into a construction zone.

Removal – When work is suspended for short periods, all signs, including roll-up signs that are no longer appropriate, shall be removed, covered, turned, or laid flat so they are not visible to drivers. Signs laid flat should not be placed such that posts present a danger to a motorist if they run over the sign.

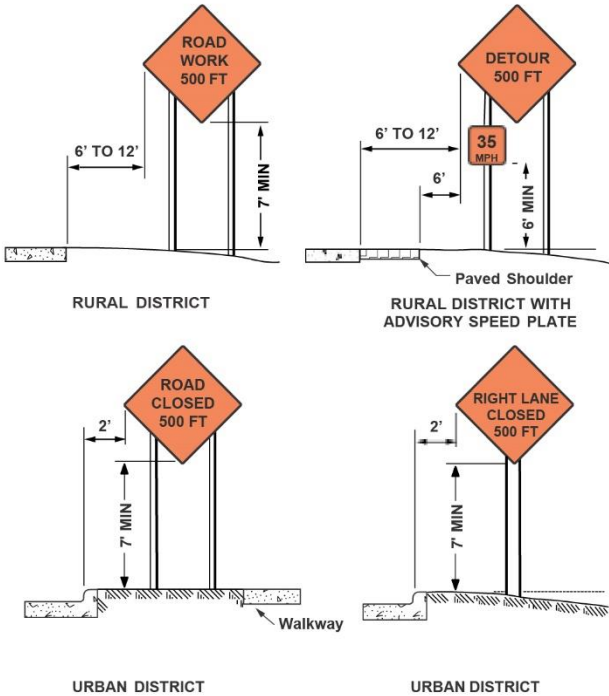

Illumination and Retroreflectorization – All signs shall be retroreflective or illuminated. (Street or highway lighting is not regarded as meeting the requirements for sign illumination.)

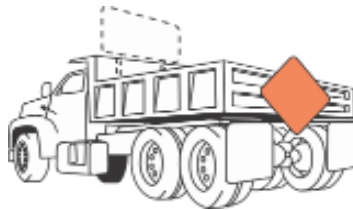
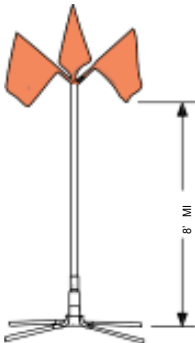
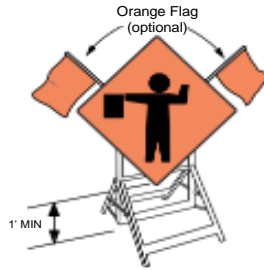
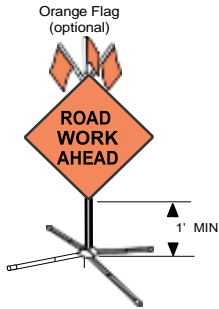

PORTABLE AND TEMPORARY

MOUNTINGS HIGH LEVEL WARNING DEVICE
(Flag Tree)

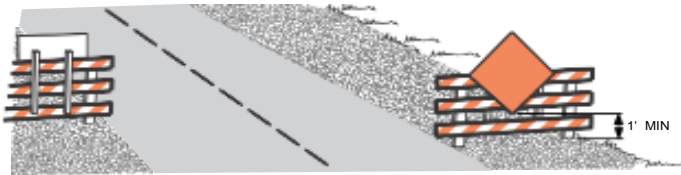

Portable Changeable Message Signs – Portable Changeable Message Signs may be used to supplement other signs, but not to substitute for any required signs. They may display a variety of messages but are typically only used to display “real time” or changing condition information.

The Changeable Message Signs shall not display more than one message consisting of no more than 2 phases (screens), and the entire message should be readable twice at the usual roadway speed limit. For guidance on locations message content including standard messages refer to the [INDOT Guidelines for Portable Changeable Message Signs](#)



Automated Flagger Assistance Devices (AFADs)

AFADs enhance safety by allowing the flagger to position off (outside) the highway shoulder and operate the device through either a handheld remote control or an app on a smart phone or tablet. They are positioned where the flagger would otherwise be located and may be used with any flagger operation. When the flagger can see either end of the work zone and both directions of travel one flagger can control both approaches.

Two types of AFADs are available- the first utilizes red and yellow lenses in which the red indication is displayed to stop and hold traffic and the yellow indication allows traffic to proceed. The second type uses STOP and SLOW signs to convey the same messages.

Portable Signals

Portable signals are used to control two directions of traffic maintained in one lane. As an option to flagging they are particularly beneficial when the operations will extend through nighttime. Two units are placed at either end of the work zone with a 100 ft merge taper provided. Timing and cycle lengths should be confirmed by the agency having jurisdiction for the roadway. Only models from INDOT's [Qualified Products List](#) may be used in the state of Indiana (regardless of the agency of jurisdiction).

Channeling Devices

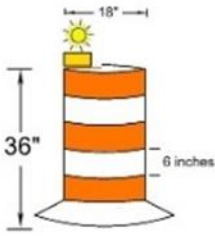

DRUM



VERTICAL PANEL

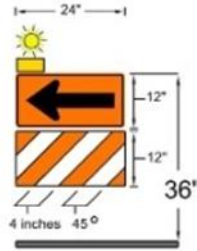

DIRECTION INDICATOR
BARRICADE

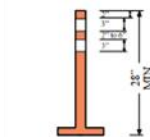

TUBULAR MARKER

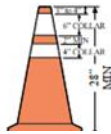

CONE



42" CHANNALIZER

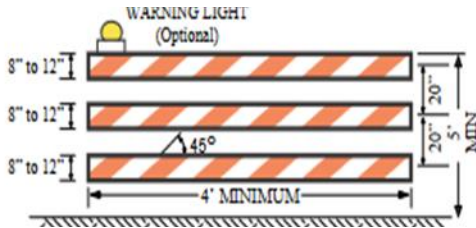

TYPE III BARRICADE

Notes:

1. Stripes on barricade rails slope downward at an angle of 45 degrees toward the direction traffic is to pass.
2. Barricade rail stripe widths shall be 6 inches except where rail lengths are less than 36 inches, then 4-inch-wide stripes may be used.
3. The sides of barricades facing traffic shall have retroreflective rail faces.
4. All channelizing devices shall meet AASHTO Manual for Assessing Safety Hardware (MASH) Requirements.

Channeling Devices

Channelizing devices are used to warn and alert road users of conditions created by work activities and to guide road users. Channelizing devices include cones, tubular markers, vertical panels, drums, barricades, and barriers.

Cones are most commonly used for short-duration maintenance and utility work. Cones used at night shall be retroreflectorized as shown on page 9. Drums are most commonly used where they will remain in place for a prolonged period, such as twelve hours or overnight. Ballast shall not be placed on top of channelizing devices.

Spacing

The spacing of channelizing devices (cones, etc.) should be a distance in feet equal to the speed limit in mph when used for taper channelization, and a distance in feet equal to 2.0 times the speed limit in mph when used for tangent channelization. See Table II on page 16.

Alternatively, the spacing may be as follows: Spacing for straight-a-ways:

- 20 to 40 mph: 1 cone for every 40 feet (every skip)
- 40 to 55 mph: 1 cone for every 80 feet (every other skip)
- 60 mph & above: 1 cone for every 120 feet (every 3 skips)

Note: Where contrast markings – black shadowing the white marking – are used for skip lines the spacing between white markings is still 40 feet.

Warning Lights

ON SIGNS AND CHANNELIZING DEVICES — Warning lights may supplement retroreflectorization on warning and channelizing devices. They are especially useful in areas prone to fog or frequent inclement weather. Warning lights shall have a minimum mounting height of thirty (30) inches. The principal types and uses of warning lights are:

1. Low intensity Flashing Lights (Type A)

May be mounted on barricades or drums to warn of an isolated hazard at night. They may also be mounted on signs.

2. High intensity Flashing Lights (Type B)

May be mounted on advance warning signs, or on independent supports to draw attention to extreme hazards both day and night.

3. Low intensity Steady-Burn Lights (Type C)

May be used in a series to delineate the edge of the travelled way and channelize traffic at night.

4. 360 degree Steady Burn Lights (Type D)

May also be used in a series to delineate the edge of the travelled way and channelize traffic at night.



ON VEHICLES — Vehicle hazard lights, four-way flashers, shall not be used as vehicle warning lights, but may be used to supplement vehicle warning lights. Vehicle warning lights are defined in the [INDOT Vehicle Lighting Policy](#). Care should be taken to avoid presenting excessive and confusing numbers of vehicle lights to motorists. Work vehicles in protected areas which are not being utilized should have their lights switched off **except when entering or exiting the zone.**

Arrow Displays

An arrow board in the arrow or chevron mode may be used to supplement signs and other devices for lane closures on multilane roadways. An arrow board in caution mode shall be used only for shoulder work, blocking the shoulder, or roadside work near the shoulder. Arrow boards shall not be used on two-lane two-way roads in arrow or chevron mode. Arrow boards may only be used in caution mode on two-lane two-way roads. Arrow boards will be equipped with a dimmer switch (manual or automatic) for nighttime work.

Panel Type	Roadway Speed	Min. Size	Min. # Lamps	Min. Legibility Distance
A	25-30 mph	24"x48"	12	1/2 mile
B	35-40 mph	30"x60"	13	3/4 mile
C	> 45 mph	48"x96"	15	1 mile

OPERATION MODE

At least one of the three following modes shall be provided:

Flashing Arrow

PANEL DISPLAY*

(Right shown;
Left similar)



Move/Merge Right

Sequential Arrow



Move/Merge Right



Sequential Chevron



Move/Merge Right



The following mode shall be provided:

Flashing Double Arrow



Move/Merge Right or Left

The following mode shall be provided:
Flashing Caution



Caution

or



Caution

*Element layout for Type C Panel shown

Arrow Display Condition

Evaluation Guide For Flashing Arrow Panels (Merge Mode)



Acceptable

No more than one (1) lamp out in stem and none out in arrowhead.
Lights dim properly.



Marginal

Two (2) or fewer lamps in stem out. No lamps out in head. Lights dim properly.



Unacceptable

Any lamp out in the arrowhead, or more than two (2) lamps out in the stem or lights do not dim properly.

Evaluation Guide For Flashing Arrow Panels (Double Arrow Mode)



Acceptable

No more than one (1) lamp out in stem and none out in arrowheads.
Lights dim properly.



Marginal

Two (2) or fewer lamps in stem out. Both arrowheads completely functional with no lamps out. Lights dim properly.

Pavement Markings

For long-term stationary projects, follow the guidelines of Part VI of the MUTCD in placing and removing pavement markings. The colors of temporary pavement markings and delineators follow the same standard as for permanent markings. When used to enhance the visibility of the roadway edge, white is specified along both sides of two-way roadways and the right side of one-way roadways. Yellow is used on the left side of one-way roadways. Centerlines and lane lines are yellow when separating opposing directions of traffic and white when separating lanes going the same direction.

Where pre-existing pavement marking conflicts with the temporary travel path, additional signing and channelizing devices are appropriate.

Fundamental Principles

The principles listed below provide a guiding philosophy of good temporary traffic control and enhance the safety of motorists, pedestrians, and workers in the vicinity of temporary traffic control zones.

1. Make traffic safety and temporary traffic control an integral and high-priority element of every project from planning through design, construction, and maintenance.
2. Inhibit traffic movement as little as possible.
3. Provide clear and positive guidance to drivers and pedestrians as they approach and travel through the temporary traffic control zone.
- 4. Inspect traffic control elements routinely and make modifications when necessary.**
5. Pay increased attention to roadside safety in the vicinity of temporary traffic control zones.
- 6. Train all employees who select, place, and maintain temporary traffic control devices.**
7. Establish proper legislative authority to implement and enforce needed traffic regulations, speed zoning, parking controls, and incident management.
8. Keep the public well informed.
9. If there is a side road intersection or ramps within the work area, additional traffic control, such as flaggers and appropriate signage, may be needed on the side road approaches or ramps.
10. Good judgment must always be used to determine the final traffic control setup.
- 11. Workers are at their most vulnerable during installation and removal of temporary traffic control devices- these steps should be done efficiently and when possible, outside of peak traffic volume times.**

Parts of a Traffic Control Zone

The traffic control zone is the distance between the first advance warning sign and the point beyond the work area where traffic is no longer affected. Below is a diagram showing the parts of a traffic control zone.

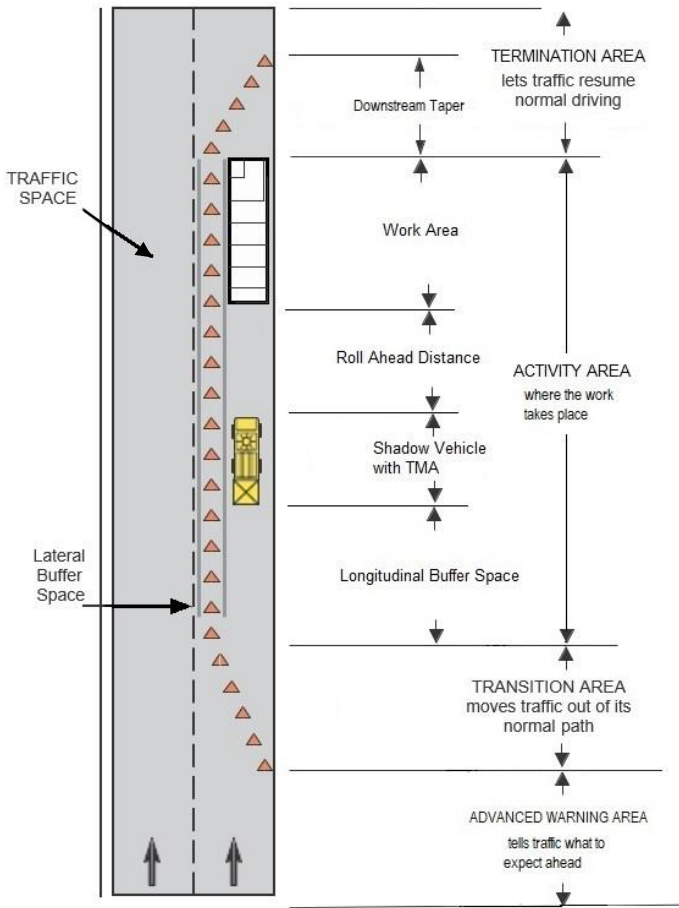

Taper Length Criteria for Work Zones

The five types of tapers used in work zone traffic control are:

Type of Tapers

1. Merging Taper – The number of lanes is reduced on a multilane road.
2. Shifting Taper – A lateral shift, but no reduction in the number of travel lanes.
3. Shoulder Taper – The shoulder is closed.
4. Two-way Traffic Taper – Opposing directions of traffic share one open lane.
5. Downstream Taper – The work area ends and traffic resumes normal driving (use is optional).

The spacing of channelizing devices (cones, drums, etc.) in a taper should be a distance in feet equal to the speed limit in mph. All taper lengths on interstates and freeways should be based on 70 mph operating speed regardless of the speed limit.

Channelizing devices may also be spaced as follows:

TABLE II: INDOT SKIPS BASED STANDARD TAPERS										
(12 Ft Closure)										
Speed (mph)	Merging Tapers			Shifting Tapers			Shoulder Tapers			
	#Skips (Length)	Cone Spacing	#Cones	#Skips (Length)	Cone Spacing	#Cones	#Skips (Length)	Cone Spacing	#Cones	
Low Speed	20	4 (160')	20	9	2 (80')	20	5	2 (80')	20	5
	25	4 (160')	20	9	2 (80')	20	5	2 (80')	20	5
	30	5 (200')	20	11	3 (120')	20	7	2 (80')	20	5
	35	7 (280')	20	15	4 (160')	20	9	3 (120')	20	7
	40	8 (320')	40	9	4 (160')	40	5	3 (120')	40	4
High Speed	45	14 (560')	40	16	7 (280')	40	8	5 (200')	40	6
	50	15 (600')	40	17	8 (320')	40	9	5 (200')	40	6
	55	17 (680')	40	18	9 (360')	40	10	6 (240')	40	7
	60	18 (720')	60	13	9 (360')	60	7	6 (240')	60	5
	65	20 (800')	60	15	10 (400')	60	8	7 (280')	60	6
	70	21 (840')	60	15	11 (440')	60	9	7 (280')	60	6
2-Way & Downstream Tapers are always 3 skips (120'), 20' cone spacing, with 7 cones										

Note: The white or yellow part of 1 skip line is 10 feet and the gap between these skips is 30 feet.

Buffer Lengths and Flagger Stations

The buffer area is a required part of the work zone. It serves to separate traffic flow from the work area or a potentially hazardous area and provides recovery space for an errant vehicle. The buffer area should not include any work activity nor storage of equipment, vehicles, or material. Buffer lengths for interstate and freeways should be based on 70 mph regardless of speed limit.

The flagger station shall be located the same distance in advance of the transition area as the buffer length and such that approaching road users will have sufficient distance to stop at an intended point. See the ATSSA Flagger Handbook for additional information.

Table III: Guidelines for Buffer Lengths, Distance of Flagger Station in Advance of the Workspace, and Roll-ahead Distances

Speed (mph)	MUTCD Buffer Length (ft.)	INDOT Skips Based		Roll-ahead Distance	
		Buffer Length (ft.)	Number of Skips	Stationary	Mobile
20	115	120	3	100	150
25	155	160	4	100	150
30	200	200	5	100	150
35	250	280	7	100	150
40	305	320	8	100	150
45	360	360	9	100	150
50	425	440	11	150	200
55	495	520	13	150	200
60	570	600	15	200	275
65	645	680	17	200	275
70	730	760	19	225	325

For taper widths less than 12 feet, consult the IMUTCD Section 6C-08, Table 6C-4.

A lateral buffer space may also be used to separate passing traffic from the work area. Its use and width are based on conditions at the worksite.

Supervisor's Checklist

1. Signed and completed Job Safety Briefing on the worksite.
2. Have a traffic control plan before going to the worksite.
3. Ask yourself, "What is the driver's view of the worksite", (at night, during peak hours, etc.) Whenever possible, after setting up, drive through the zone to see it from the motorist's perspective.
4. Investigate crashes/incidents to identify if changes are needed in the traffic control plan.
5. For overhead work, traffic control is required for affected lane(s).
6. If working on an interstate, check with the Unit Supervisor or Sub District Manager to see if an exception to the [Interstate Highways Congestion Policy](#) is needed and/or approved for the location. If an exception is needed contact the District Technical Services Director or Traffic Engineer.

Planning the Layout

The key to good traffic control is to apply the guidelines using proper judgment. Consider factors such as duration of work, location of work, and characteristics of the roadway.

Duration of Work

Work duration is a major factor in determining the number and types of devices used in temporary traffic control zones. As a general rule, the longer the operation will last, the more traffic control devices are needed. Also, as the work time is short, the time during which motorists are affected is significantly increased when additional devices are installed and removed. Considering these factors, it is generally held that simplified control procedures are warranted for short-duration activities. Such shortcomings may be offset by the use of other, more dominant devices, such as special lighting units on work vehicles.

Long-Term Stationary – Work that occupies a location more than three (3) days.

Intermediate-Term Stationary – Work that occupies a location from overnight to three (3) days.

Short-Term Stationary – Daytime work that occupies a location for one (1) to twelve (12) hours.

Short Duration – Work that occupies a location up to one (1) hour.

Mobile – Work that moves intermittently or continuously.

Location of Work

The choice of traffic control needed for a temporary traffic control zone depends upon where the work is located. As a general rule, the closer the work is to traffic, the more traffic control devices are needed.

Traffic Control Devices Set Up and Take Down

Traffic control devices including all signs, drums, and cones should be installed beginning with the farthest device from the work area. Devices should be removed in the reverse order starting with the closest to the work area. This sequence maximizes the amount of information conveyed to the motorist during installation and removal.

What Traffic Control Set-Up Should I Use?

These questions should be considered and answered to provide proper worksite traffic control:

1. What is the type of road (two-lane or multi-lane) on which we will be working?
2. Are we working on the roadway or shoulder?
3. How long will we be at a location?
4. Is extra protection needed?
5. Is a lane being restricted or encroached upon?
6. Will work be during the day or at night?
7. If working at night is additional lighting needed (existing roadway lighting in place)?
8. Is an IHCP exception needed?
9. For non-freeways what is the prevailing posted speed limit? For freeways and interstates assume 70 mph.

Curvy and Hilly Locations

These locations may require extra work zone safety measures, including extending the length of the work zone to allow for more stopping distance by road users. The Highway Maintenance Director may be consulted for guidance on unusual or difficult situations.

Nighttime Traffic Control

Extra care should be taken when scheduling work at night. Plan ahead whenever possible, involving all affected personnel, to ensure that everyone understands what is expected of them and that you have the proper traffic control equipment for the job. As stated on page 1 of this manual, the immediate response to an emergency situation must by necessity make use of available devices and equipment. Given the opportunity, however, longer term emergencies should be treated in a manner similar to temporary traffic control as soon as possible.

The work zone traffic control mentioned in this manual are the minimum requirements and extra controls should be utilized when needed. Closing additional lanes when possible and the use of message boards are just two of the tools available.

Specifically, the following are guidelines to follow when performing nighttime activities:

All Required Personal Protective Equipment: High visibility safety apparel shall be worn during nighttime operations. Refer to the work process standard and INDOT [Safety and Health Manual](#) for all required PPE including the use of reflective leg bands.

Signs: Must be retroreflective (see page 6 of this manual for more details)

Message Boards: Portable message signs may be used to alert the public of the work ahead. See page 7 for specific details and how the sign should be used. It can be a good practice to display a message a day ahead of the work warning about the coming change.

Arrow Boards: Lights should be dimmed for night operations (most boards dim automatically).

Channelizing Devices: Cones must be 28" tall and have retroreflective tape. Barrels must have retroreflective tape or Warning Lights (as required). Barricade panel must be Type 3. (See page 9 of this manual for more details.) It is also good practice to have night patrols available to reset traffic control devices as needed.

Lighting-Worksite Illumination: Portable light towers with generators should be used to illuminate the work area. The preferred light strength should be Class III 215 lux (20 foot-candles). Every effort shall be made to prevent glare affecting oncoming traffic. To minimize glare luminaires should be aimed at least 60° from horizontal, tower mounting heights should be at least 18 feet while balloon style temporary lights should be mounted at a minimum of 10 feet. Except in emergency situations flagger stations must be illuminated when flagging is performed at night.

Night Time Traffic Control (cont.)

Vehicle Work Lights: Lights shall be added to work equipment as needed. Equipment lighting shall also be positioned to prevent glare to motorists.

General Safety: Trucks pulling arrow boards for nighttime operations should turn off all warning lights and flashers to the rear to prevent distracting from the view of the arrow board. Headlights should be on during mobile operations.

Typical Application Diagrams

The diagrams on the following pages represent examples of the application of principles and procedures for safe and efficient traffic control in work zones but are not intended to be standards.

It is not possible to include illustrations to cover every situation which will require work area protection. These typical layouts are not intended as a substitute for engineering judgment and should be altered to fit the conditions of a particular site.

Contract plans or other agency documents may also have applicable layouts to be followed.

The diagrams are not to scale, and the number of channelizing devices shown may not be the number needed at the worksite. **Work vehicles are not shown in the diagrams.** Use the tables on the typical diagrams to determine taper and buffer lengths, and use pages 10 and 16 for guidance on the spacing and number of devices.

The notes and tables on the typical diagrams provide important information for the user. All items shown on diagrams are to be considered mandatory, unless stated otherwise.

Read all notes before using these diagrams. The information presented in these diagrams and tables are generally minimums. For further information, refer to Part VI of the IMUTCD. This contains the standards for work zone traffic control.

Legend

	Channelizing Device		Shadow Vehicle With Flashing Light
	Arrow Board Display		High Level Warning Device
	Flagger Symbol		Work Area
	Portable Sign Support		Warning Sign
	Arrow Board Display Symbol		Shadow Vehicle with Truck or Trailer-Mounted Attenuator (TMA)
	Changeable Message Sign		Type III Barricade

Shadow vehicles for INDOT shall have a minimum weight of 10,000 lbs. A load of sand may be required to obtain the minimum weight, but it should not be permitted to freeze during winter operations. If a TMA is used, the truck shall be loaded per the TMA manufacturer's specifications. Shadow vehicles should be parked parallel to traffic and have the front wheels angled away from traffic.

Signs must not be placed on the attenuator as this may adversely affect the crashworthiness of the attenuator. Rather signs should always be placed on the vehicle.

Definitions of Terms

Shall/Mandatory – Required condition.

Should/Recommend – An advisory condition. Where these words are used, they are considered to be advisable usage. Recommendations are to be followed unless specific circumstances do not allow.

May/Optional – A permissive condition. No requirement for design or application is intended.

Shadow Vehicle – Is a moving truck with an impact attenuator either placed on the truck itself or on a trailer being pulled by the truck. A shadow vehicle is spaced at the appropriate distance from a moving operation depending on truck weight and highway operating speed, giving physical protection to workers from traffic approaching from the rear. If the shadow vehicle will be located primarily off the travel way and shoulder use if the impact attenuator is optional.

Unmanned Shadow (Blocker or Barrier) Vehicle – The shadow vehicle may be left unmanned through operations that are at least of short duration or longer. This option may be particularly beneficial on high-speed, high-volume roads.

Pilot Vehicle – A pilot vehicle is used to guide a queue of traffic through the work zone in one lane, two-way traffic control situations where drivers cannot see from one end of the work zone to the other. They are used in conjunction with flaggers but not temporary traffic signals. A “PILOT CAR FOLLOW ME” sign is required on the rear of the vehicle. The vehicle may be either a car or truck.

For work not specifically covered in this WZTCG, the IMUTCD will need to be consulted, but where this WZTCG has added devices, etc., this WZTCG shall take precedence.

**Short Term Stationary
(1 to 12 hours)**

***Work off the Traveled Lanes
Includes Paved Shoulder < 8ft.
(Short Term Stationary - 1 to 12 hours)***

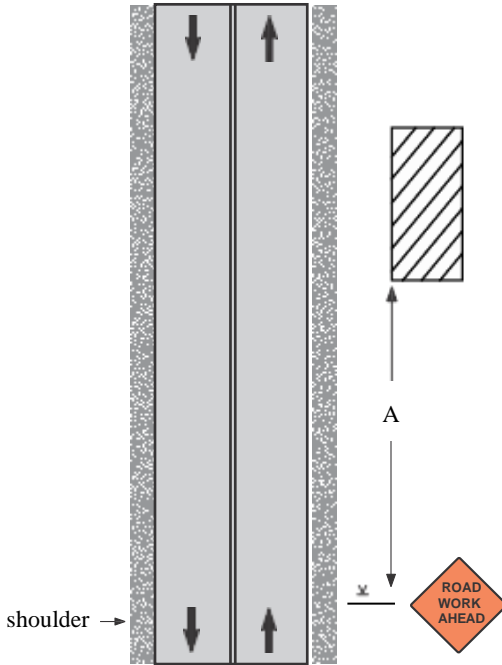

Notes:

1. Other acceptable advance warning signs are those indicating SHOULDER WORK, UTILITY WORK AHEAD, or the WORKERS sign.
2. An advance warning sign should be used; if the work will be performed immediately adjacent to the shoulder, if equipment will cross or move along the roadway, or if the activity may distract motorists.
3. Warning signs may be eliminated if the workspace is behind a barrier, more than 2 feet behind a curb, or 15 feet or more from the edge of any traveled lane.
4. For work beyond the shoulder, all warning signs and channelizing devices are optional if a vehicle with activated warning lights is used.

Speed Limit (mph)	Sign Spacing A (ft.)
25	100
30	100
35	350
40	350
45	500
50	500
55	500
60	1000

Work on Paved Shoulders >8 feet or Parking Lanes

(Short Term Stationary – 1 to 12 hours)

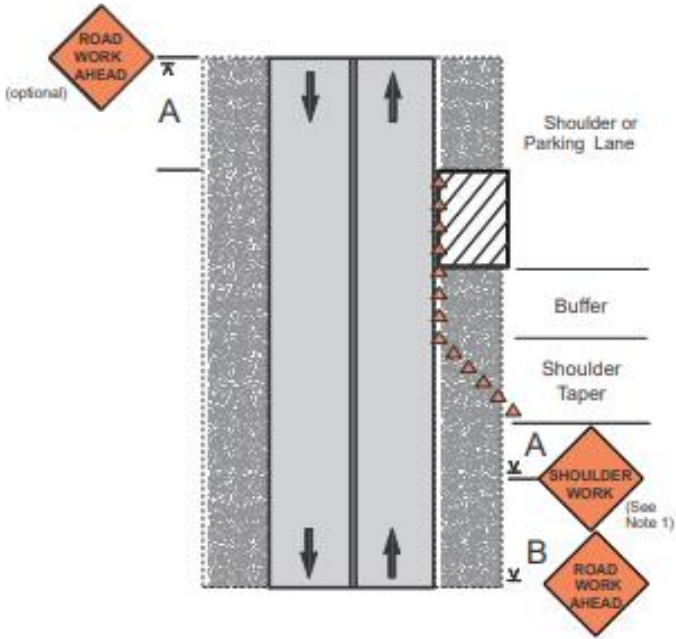

Notes:

1. SHOULDER CLOSED, WORKERS or UTILITY WORK AHEAD signs may be used instead of the SHOULDER WORK or ROAD WORK AHEAD signs.

Speed Limit (mph)	Sign Spacing (ft.)		Buffer (ft.)
	A	B	
25	100	100	160
30	100	100	200
35	350	350	280
40	350	350	320
45	500	500	360
50	500	500	440
55	500	500	520
60	1000	1000	600

***Paved Shoulder >8 feet
Closed on Divided Roadway
(Short Term Stationary – 1 to 12 hours)***

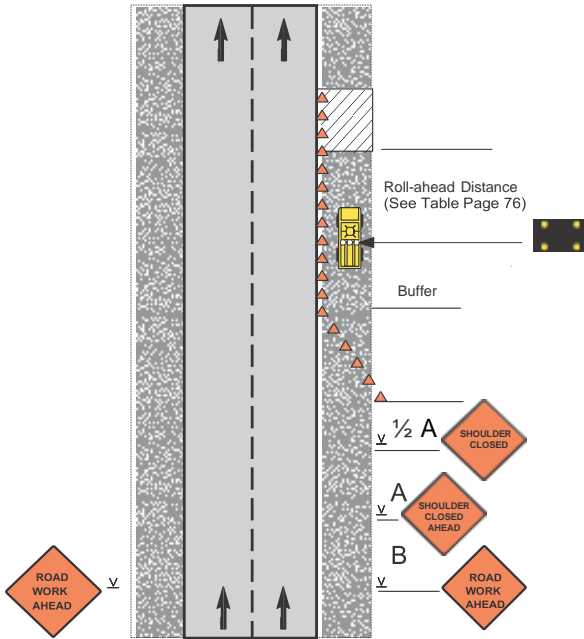

Notes:

1. SHOULDER CLOSED signs should be used on limited-access highways where there is no opportunity for disabled vehicles to pull off the traveled way.
2. UTILITY WORK AHEAD or WORKERS signs may be used instead of the ROAD WORK AHEAD sign.
3. Use of an arrow display is optional. If used, it shall be operated in caution mode.
4. On non-freeway multilane roads in urban areas, the sign spacing may be reduced as shown in the chart on page 3.
5. Sign spacing and buffer lengths for freeways should be based on 70 mph regardless of posted speed limit.

Speed Limit (mph)	Sign Spacing (ft.)		Buffer (ft.)
	A	B	
35	350	350	280
40	350	350	320
45	500	500	360
50	1000	1600	440
55	1000	1600	520
60	1000	1600	600
65	1000	1600	680
70	1000	1600	760

Lane Closure on a Two-Lane Road (Two Flagger Operation)

(Short Term Stationary – 1 to 12 hours)

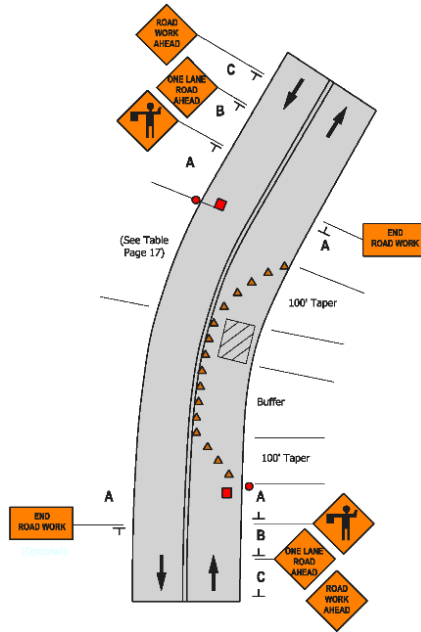

Notes:

1. The flaggers shall use approved flagging procedures according to the MUTCD and as shown on pg. 77.
2. If there is a side road intersection within the work area, additional traffic control, such as flaggers and appropriate signage, shall be used on the side road approaches.
3. If the work area is in or adjacent to a horizontal or vertical crest curve, the buffer spaces should be extended so that the two-way taper is placed before the curve to provide better sight distance for the flagger.
4. If portable rumble strips are used, they must be placed adjacent to the ONE LANE ROAD AHEAD signs.

Speed Limit (mph)	Sign Spacing (ft.)			Buffer (ft.)
	A	B	C	
25	100	100	100	160
30	100	100	100	200
35	350	350	350	280
40	350	350	350	320
45	500	500	500	360
50	500	500	500	440
55	500	500	500	520
60	1000	1600	2640	600

Center Turn Lane Closed

(Short Term Stationary – 1 to 12 hours)

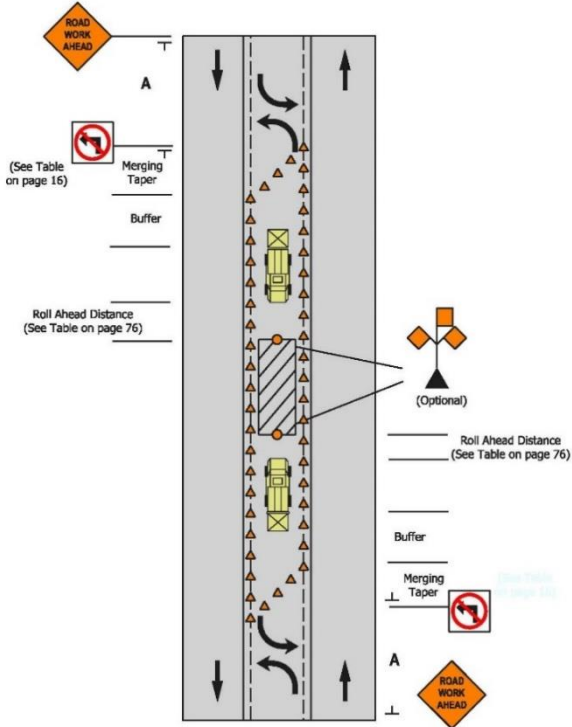

Notes:

1. LARGE ARROW sign may be used at the taper for added visibility.
2. NO LEFT TURN sign may be omitted for roadways with low volume ($\leq 3,000$ AADT) or low left-turn volumes (≤ 60 vehicles/hour).
3. Arrow boards on shadow vehicles shall be in caution mode.

Speed Limit (mph)	Sign Spacing A (ft.)	Buffer (ft.)
25	100	160
30	100	200
35	350	280
40	350	320
45	500	360
50	500	440
55	500	520
60	1000	600

Lane Shift on a Three-Lane Two-Way Road

(Short Term Stationary – 1 to 12 hours)

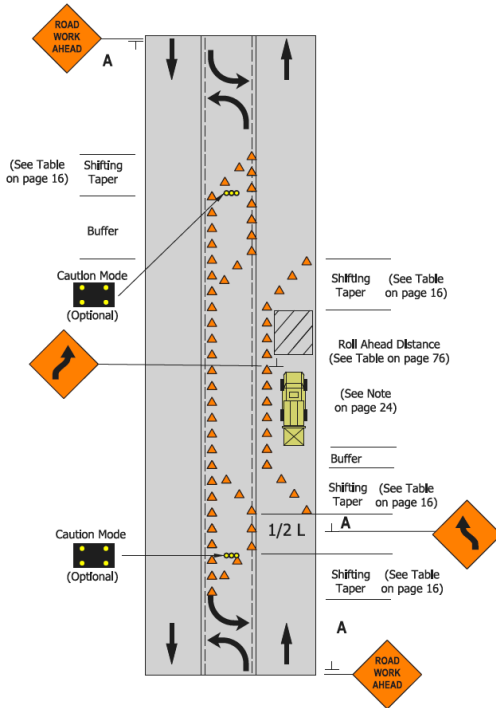

Notes:

1. LARGE ARROW signs may be used at the shifts for added visibility.
2. If the speeds are 30 mph or less, REVERSE TURN signs shall be used instead of REVERSE CURVE.
3. If an arrow board is used on the shadow vehicle, then it shall be in caution mode.

Speed Limit (mph)	Sign Spacing A (ft.)	Buffer (ft.)
25	100	160
30	100	200
35	350	280
40	350	320
45	500	360
50	500	440
55	500	520
60	1000	600

Interior Lane Closure on a Four-Lane Undivided Road

(Short Term Stationary – 1 to 12 hours)

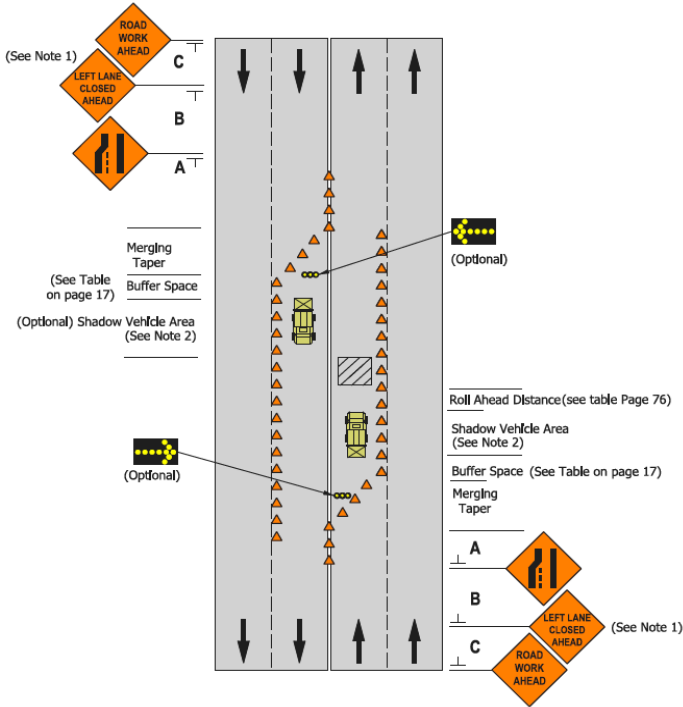

Notes:

1. <40mph speed limit LEFT LANE CLOSED AHEAD sign is optional.
2. If arrow boards are used on the shadow vehicles, then they shall be in caution mode.
3. The closure of the adjacent interior lane in the opposing direction may not be necessary, depending upon the activity being performed and the workspace needed for the operation.

Speed Limit (mph)	Sign Spacing (ft.)			Buffer (ft.)
	A	B	C	
25	100	100	100	160
30	100	100	100	200
35	350	350	350	280
40	350	350	350	320
45	500	500	500	360
50	500	500	500	440
55	500	500	500	520
60	1000	1600	2640	600
65	1000	1600	2640	680

Lane Closure on Divided Roadway or One Way Street

(Short Term Stationary – 1 to 12 hours)

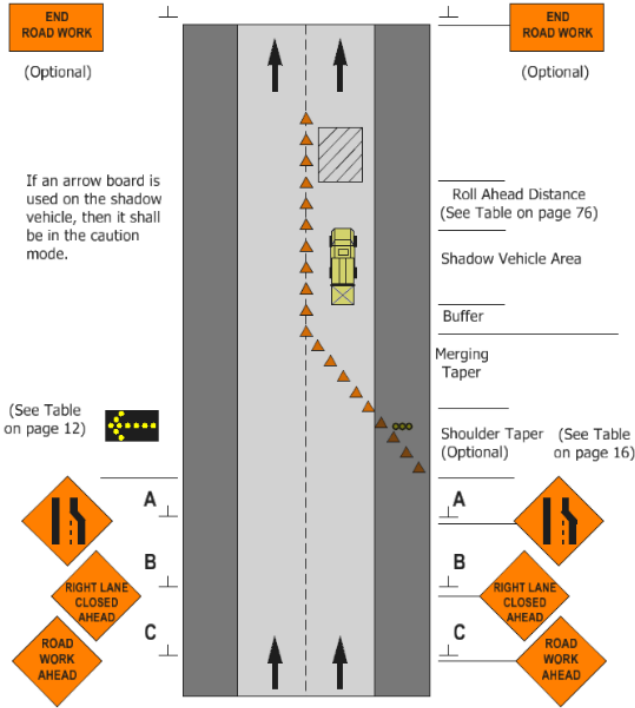

Notes:

1. When a side road intersects the roadway within the work zone, additional devices shall be erected to channelize traffic to/from the side road, and a ROAD WORK AHEAD sign shall be placed on each side road approach.
2. On non-freeway multi-lane roads in urban areas, the sign spacing may be reduced as shown in the chart on page 3.
3. Sign spacing and buffer lengths for freeways should be based on 70 mph regardless of posted speed limit.

Speed Limit (mph)	Sign Spacing (ft.)			Buffer (ft.)
	A	B	C	
30	100	100	100	200
35	350	350	350	280
40	350	350	350	320
45	500	500	500	360
50	1000	1600	2640	440
55	1000	1600	2640	520
60	1000	1600	2640	600
65	1000	1600	2640	680
70	1000	1600	2640	760

Double Lane Closure on Divided Roadway

(Short Term Stationary – 1 to 12 hours)

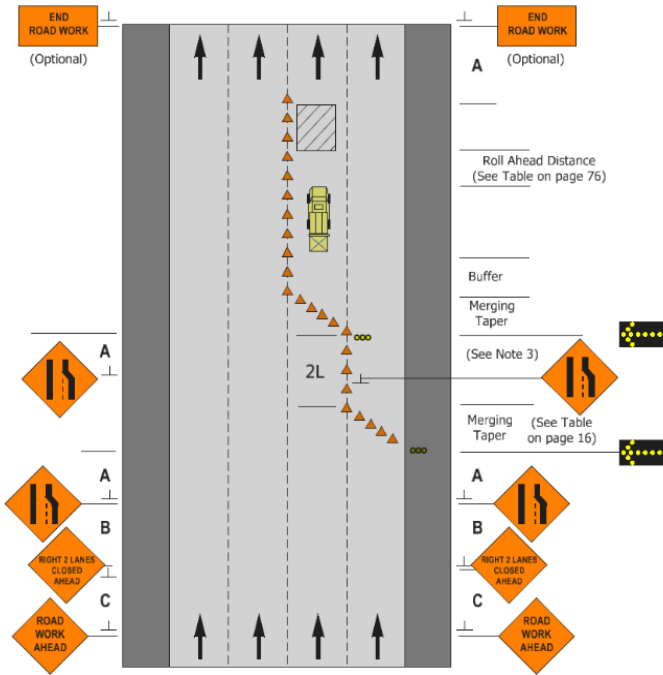

Notes:

1. When a side road intersects the roadway within the work zone, additional devices shall be erected to channelize traffic to/from the side road, and a ROAD WORK AHEAD sign shall be placed on each side road approach.
2. On non-freeway multilane roads in urban areas, the sign spacing may be reduced as shown in the chart on page 3.
3. 1,560 feet for < 65mph. 1,680 feet for 70 mph.
4. If an arrow board is used on the shadow vehicle, then it shall be in caution mode.
5. Sign spacing and buffer lengths for freeways should be based on 70 mph regardless of posted speed limit.

Speed Limit (mph)	Sign Spacing (ft.)			Buffer (ft.)
	A	B	C	
30	100	100	100	200
35	350	350	350	280
40	350	350	350	320
45	500	500	500	360
50	1000	1600	2640	440
55	1000	1600	2640	520
60	1000	1600	2640	600
65	1000	1600	2640	680
70	1000	1600	2640	760

Half Road Closure on Multilane Roadway

(Short Term Stationary – 1 to 12 hours)

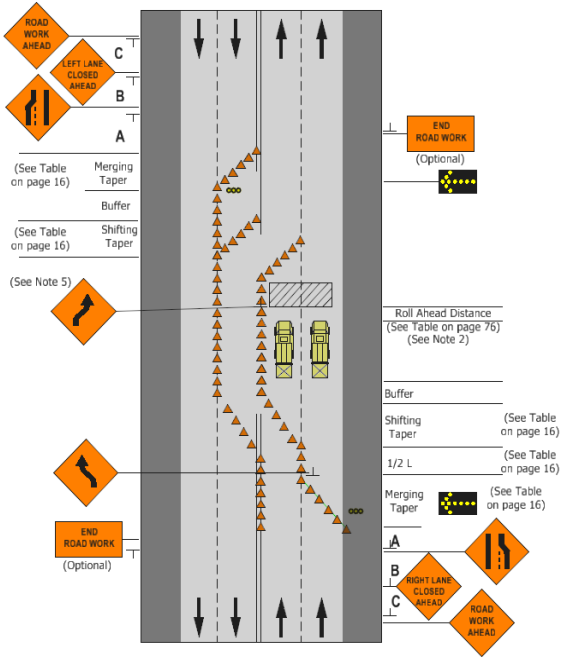

Speed Limit (mph)	Sign Spacing (ft.)			Buffer (ft.)	Roll-ahead Distance	
	A	B	C		Stationary	Mobile
25	100	100	100	160	100	150
30	100	100	200	200	100	150
35	350	350	350	280	100	150
40	350	350	350	320	100	150
45	500	500	500	360	100	150
50	500	500	500	440	150	200
55	500	500	500	520	150	200
60	1000	1600	2640	600	200	275

Half Road Closure on Multilane Roadway (cont.)

(Short Term Stationary – 1 to 12 hours)

Notes:

1. Shadow vehicle in right lane is optional. If an arrow board is used on the shadow vehicle(s), then it shall be in caution mode.
2. Channelizing devices shall be more closely spaced when the pavement markings conflict with the temporary travel path. Spacing shall be no more than $\frac{1}{2} S$, where S is the posted speed limit.
3. When a side road intersects the roadway within the work zone, additional devices shall be erected to channelize traffic to/from the side road and a ROAD WORK AHEAD sign shall be placed on each side road approach.
4. Where the tangent distance along the diversion is less than 600 ft a double reverse curve sign should be used instead of the first reverse curve sign and the second reverse curve sign should be omitted.
5. The sequence of this set-up should be closure of the second lane from the left first, then closure of the farthest right lane, then the lane shift. Take down should be in the reverse order.
6. A TMA should be used in the closed SB lane on roadways with high speeds (45 mph or higher posted limit) and high traffic volumes (>10,000 AADT).

**Mainline Right Lane Closed,
Entrance Ramp Open**
(Short Term Stationary – 1 to 12 hours)

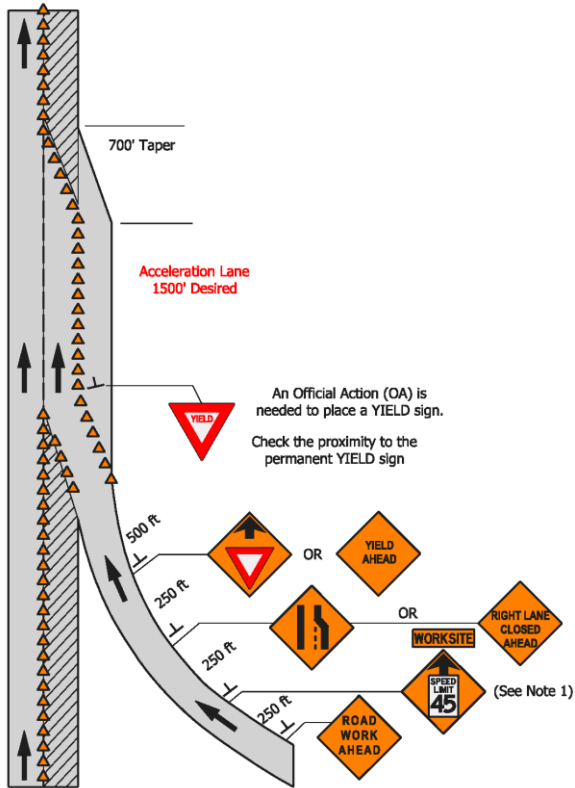

Notes:

1. An advisory 45 mph speed sign on ramp is optional if mainline speed limit has been temporarily reduced to 45 mph.
2. The Yield sign should be located directly across from physical gore point when traffic is merging with an open right lane.
3. Sometimes closing the ramp may be the best option particularly when adjacent interchanges are close (within 5 miles) and when the detour route is on the state highway system. In this situation, in lieu of maintaining ramp access as shown in the figure, the ramp may be closed with approval to an IHCP exception request. PCMS should be used on the side road to notify drivers of the closure and detour route.

**Mainline Left Lane Closed,
Entrance Ramp Open**
(Short Term Stationary – 1 to 12 hours)

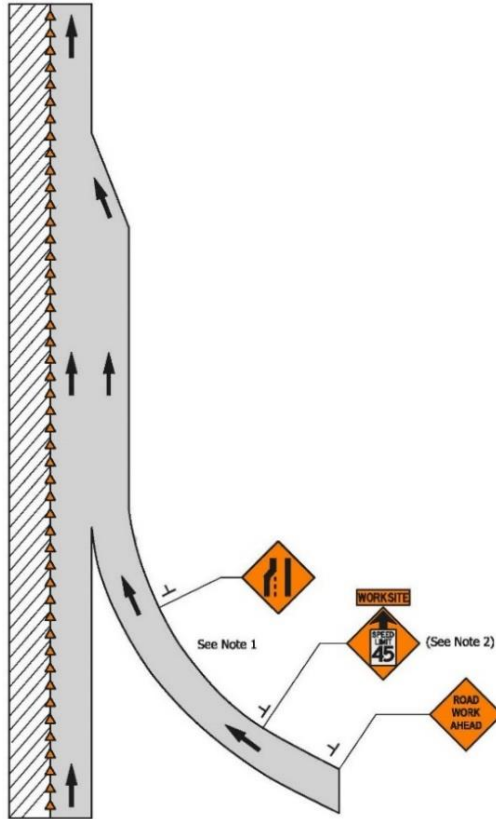

Notes:

1. The advance warning sign spacing is dependent on the ramp length and location of existing signing. The spacing should be as long as possible.
2. An advisory 45 mph speed sign on ramp is optional if mainline speed limit has been temporarily reduced to 45 mph.

Work in Vicinity of Exit Ramp – Right side of Ramp

(Short Term Stationary – 1 to 12 hours)

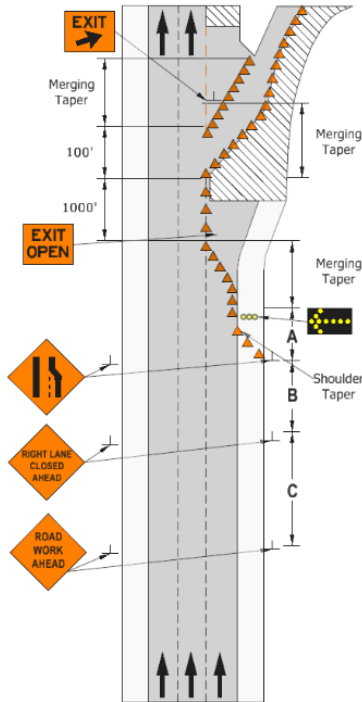

Notes:

1. Closing the ramp may be the best option if temporary geometrics (angle of exit, ramp width) cannot be provided.
2. Sign spacing and buffer lengths for freeways should be based on 70 mph regardless of posted speed limit.

Speed Limit (mph)	Sign Spacing (ft.)			Buffer (ft.)
	A	B	C	
25	100	100	100	160
30	100	100	100	200
35	350	350	350	280
40	350	350	350	320
45	500	500	500	360
50	1000	1600	2640	440
55	1000	1600	2640	520
60	1000	1600	2640	600
65	1000	1600	2640	680
70	1000	1600	2640	760

Work in Vicinity of Exit Ramp – Left side of Ramp

(Short Term Stationary – 1 to 12 hours)

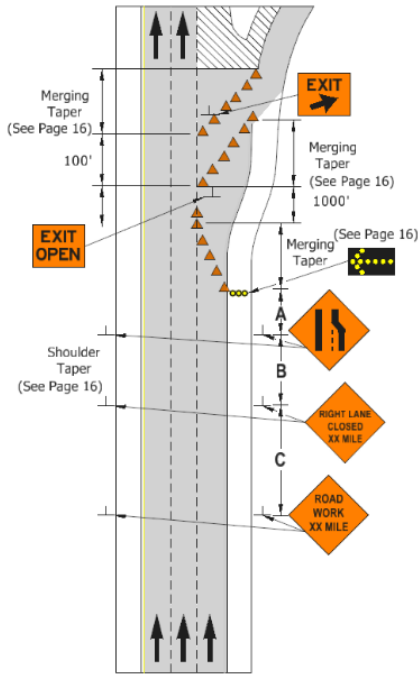

Notes:

1. Closing the ramp may be the best option if temporary geometrics (angle of exit, ramp width) cannot be provided.
2. Sign spacing and buffer lengths for freeways should be based on 70 mph regardless of posted speed limit.

Speed Limit (mph)	Sign Spacing (ft.)			Buffer (ft.)
	A	B	C	
25	100	100	100	160
30	100	100	100	200
35	350	350	350	280
40	350	350	350	320
45	500	500	500	360
50	1000	1600	2640	440
55	1000	1600	2640	520
60	1000	1600	2640	600
65	1000	1600	2640	680
70	1000	1600	2640	760

Partial Ramp Closure *(Short Term Stationary – 1 to 12 hours)*

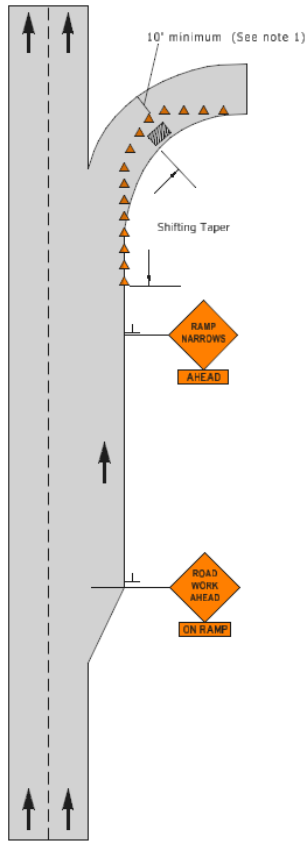

Notes:

1. Truck off-tracking should be considered when determining whether the 10-foot minimum lane width is adequate.
2. For work on the outside of the ramp, the cones will be shifted to that side, and the gore area extended upstream.
3. The RAMP NARROWS sign may be obtained from LSC.

Partial Ramp Closure Work in Gore Area

(Short Term Stationary – 1 to 12 hours)

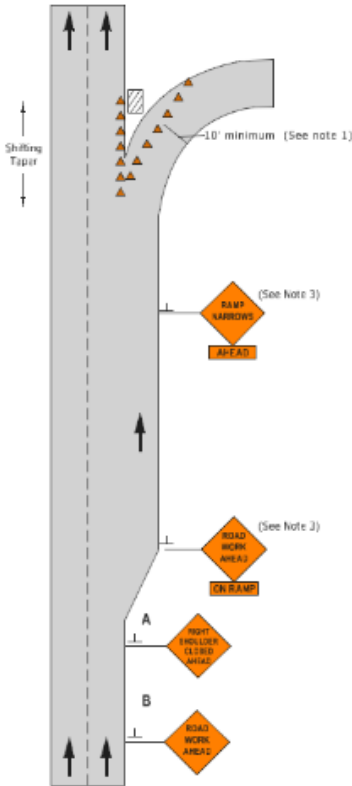

Notes:

1. Truck off-tracking should be considered when determining whether the 10-foot minimum lane width is adequate.
2. If a 10-foot lane width cannot be maintained in the right lane due to encroachment, then a shifting taper shall be used for the travel lanes provided that the left shoulder can carry trucks.
3. Required, if coned area or work area extends into the ramp.

Speed Limit (mph)	Sign Spacing (ft.)	
	A	B
25	100	100
30	100	100
35	350	350
40	350	350
45	500	500
50	1000	1600
55	1000	1600
60	1000	1600
65	1000	1600
70	1000	1600

Lane Closure in Advance of an Intersection (Work Area on the Major Road)

(Short Term Stationary – 1 to 12 hours)

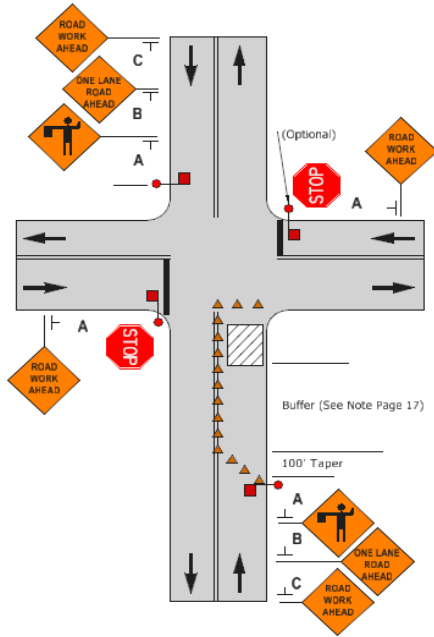

Notes:

1. Depending on traffic conditions, additional traffic control, such as flaggers and appropriate signage, may be needed on the side road approaches.
2. The middle flagger (optional) has the best view of traffic from all directions. “Flagger Ahead” symbolic signs shall be used in all four directions when the optional middle flagger is used.
3. The flaggers shall use approved flagging procedures according to the IMUTCD and as shown on page 77.
4. Sign paddles shall not to be used at signalized intersections. Red flags only. At high volume signalized intersections, consider placing the traffic lights on all way red flash.
5. Stop signs that conflict with flagger paddles shall be covered.

Speed Limit (mph)	Sign Spacing (ft.)			Buffer (ft.)
	A	B	C	
25	100	100	100	160
30	100	100	100	200
35	350	350	350	280
40	350	350	350	320
45	500	500	500	360
50	500	500	500	440
55	500	500	500	520
60	1000	1600	2640	600

Lane Closure in Advance of an Intersection (Work Area on the Minor Road)

(Short Term Stationary – 1 to 12 hours)

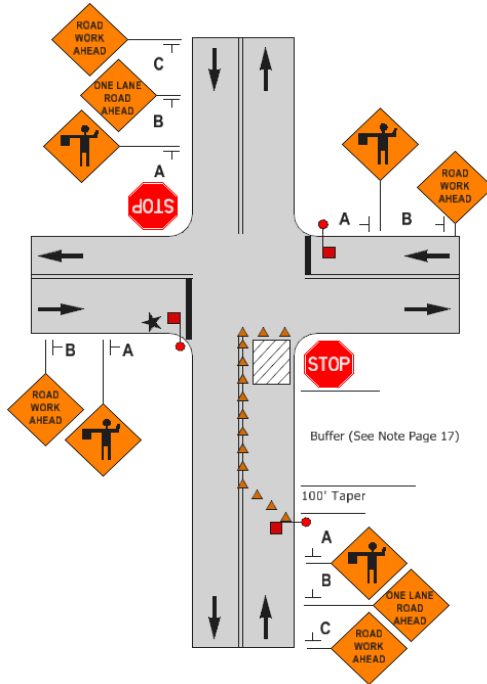

Notes:

1. Depending on traffic conditions, additional traffic control, such as flaggers and appropriate signage, may be needed.
2. The middle flagger (★) has the best view of traffic from all directions. This flagger should be designated **lead flagger** and should coordinate the actions of the other flaggers.
3. The flaggers shall use approved flagging procedures according to the IMUTCD and as shown on page 77.
4. Sign paddles shall not to be used at signalized intersections. Red flags only. At high volume signalized intersections, consider placing the traffic lights on all way red flash.

Speed Limit (mph)	Sign Spacing (ft.)			Buffer (ft.)
	A	B	C	
25	100	100	100	160
30	100	100	100	200
35	350	350	350	280
40	350	350	350	320
45	500	500	500	360
50	500	500	500	440
55	500	500	500	520
60	1000	1600	2640	600

***Lane Closure Beyond an Intersection
(Work Area on the Major Road)***
(Short Term Stationary – 1 to 12 hours)

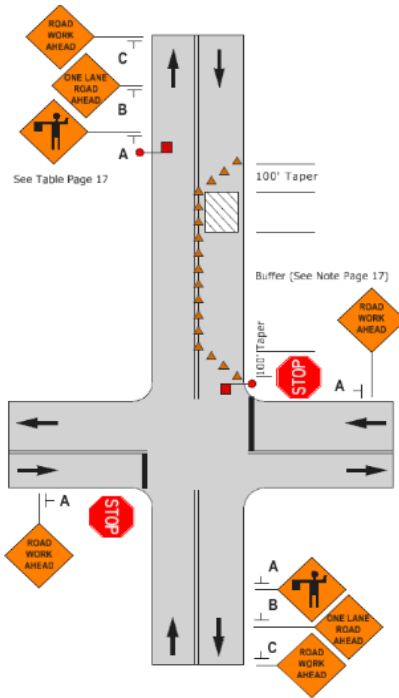

Notes:

1. Depending on traffic conditions, additional traffic control, such as flaggers and appropriate signage, may be needed.
2. The flaggers shall use approved flagging procedures according to the IMUTCD and as shown on page 77.
3. When there is insufficient space the Taper and Buffer distances may be reduced.
4. Sign paddles shall not to be used at signalized intersections. Red flags only. At high volume signalized intersections, consider placing the traffic lights on all way red flash.

Speed Limit (mph)	Sign Spacing (ft.)			Buffer (ft.)
	A	B	C	
25	100	100	100	160
30	100	100	100	200
35	350	350	350	280
40	350	350	350	320
45	500	500	500	360
50	500	500	500	440
55	500	500	500	520
60	1000	1600	2640	600

***Lane Closure Beyond an Intersection
(Work Area on the Minor Road)***
(Short Term Stationary – 1 to 12 hours)

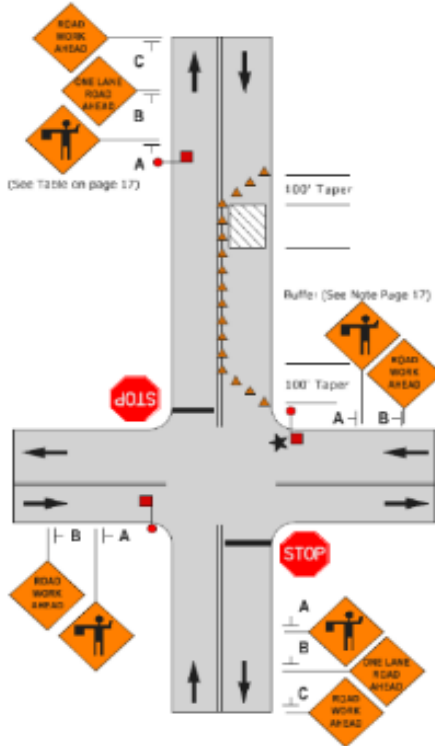

Speed Limit (mph)	Sign Spacing (ft.)			Buffer (ft.)
	A	B	C	
25	100	100	100	160
30	100	100	100	200
35	350	350	350	280
40	350	350	350	320
45	500	500	500	360
50	500	500	500	440
55	500	500	500	520
60	1000	1600	2640	600

Lane Closure Beyond an Intersection (cont.)

(Short Term Stationary – 1 to 12 hours)

Notes:

1. Depending on traffic conditions, additional traffic control, such as flaggers and appropriate signage, may be needed.
2. The middle flagger (★) should be designated **lead flagger** and should coordinate the actions of the other flaggers.
3. **The flaggers shall use approved flagging procedures according to the IMUTCD and as shown on page 77.**
4. When there is insufficient space the Taper and Buffer distances may be reduced.
5. Sign paddles shall not be used at signalized intersections. Red flags only. At high volume signalized intersections, consider placing the traffic lights on all way red flash.

Lane Closure at a Multilane Intersection (Short Term Stationary – 1 to 12 hours)

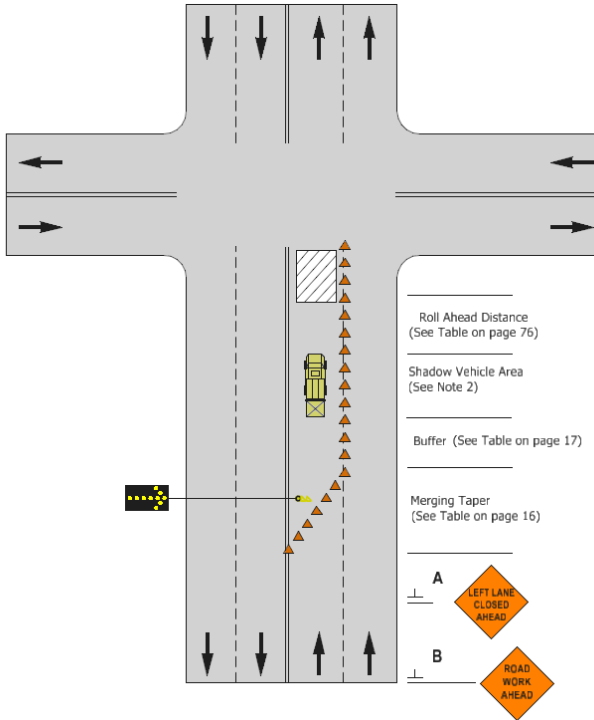

Notes:

1. The length of tapers may be adjusted when used in close proximity to crossroads, curves, or other influencing factors.
2. If working on the far side of an intersection, see page 49.

Speed Limit (mph)	Sign Spacing (ft.)		Buffer (ft.)	Roll-ahead Distance	
	A	B		Stationary	Mobile
25	100	100	160	100	150
30	100	100	200	100	150
35	350	350	280	100	150
40	350	350	320	100	150
45	500	500	360	100	150
50	500	500	440	150	200
55	500	500	520	150	200
60	1000	1000	600	200	275

Turn Lane Closure at an Intersection (Short Term Stationary – 1 to 12 hours)

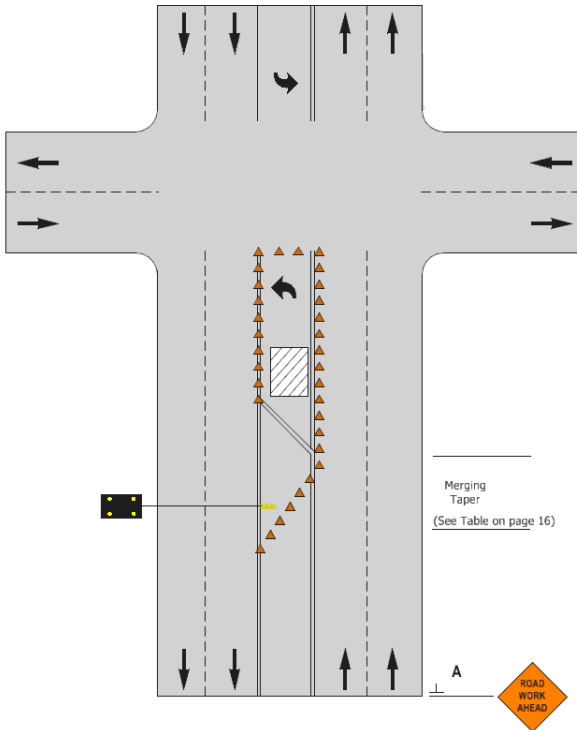

Notes:

1. Lane may be opened beyond work area.
2. The length of the tapers may be adjusted when used in close proximity to crossroads, curves, or other influencing factors.
3. Symbolic no left turn sign should be considered where left turn volumes are high during the closure period or where the closure will be in place during peak hour periods.

Speed Limit (mph)	Sign Spacing A (ft.)
25	100
30	100
35	350
40	350
45	500
50	500
55	500
60	1000

Lane Closure on Far Side of Intersection (Speeds of 35 mph or less)

(Short Term Stationary – 1 to 12 hours)

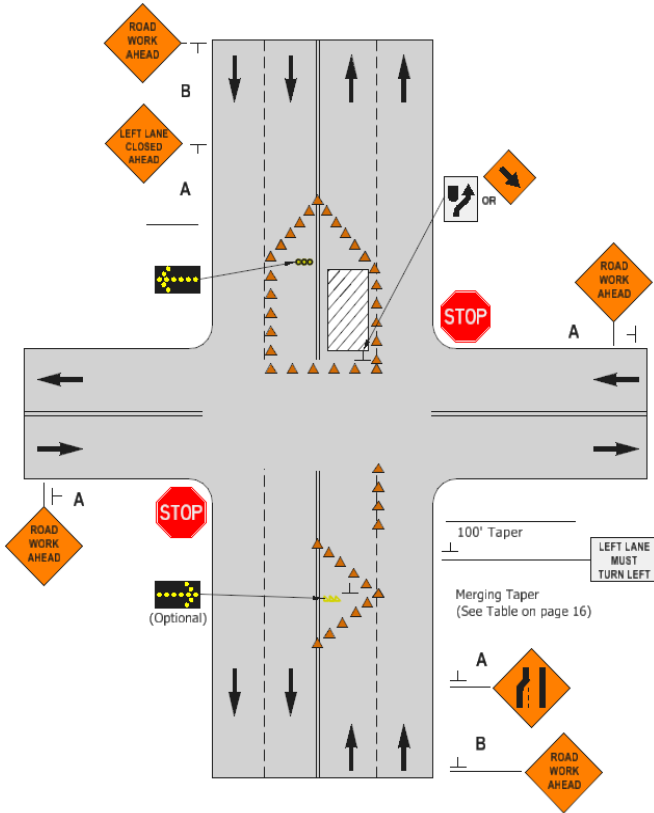

Notes:

1. This layout is only appropriate for roads with speeds of 35 mph or less. For higher speeds, see table on page 16 for advance signing and taper layout.
2. Standard procedure is to close any lane that is not carried through the intersection on the near side of the intersection. However, if this results in the closure of a lane having significant turning movements, then that lane may be converted to a turn bay, and/or the lane may be restricted to turns only, as shown.
3. A LARGE ARROW sign may be used instead of the KEEP RIGHT or DOWN ARROW sign where space permits.

Speed Limit (mph)	Sign Spacing (ft.)	
	A	B
25	100	100
30	100	100
35	350	350

Closure in Center of Intersection

(Short Term Stationary – 1 to 12 hours)

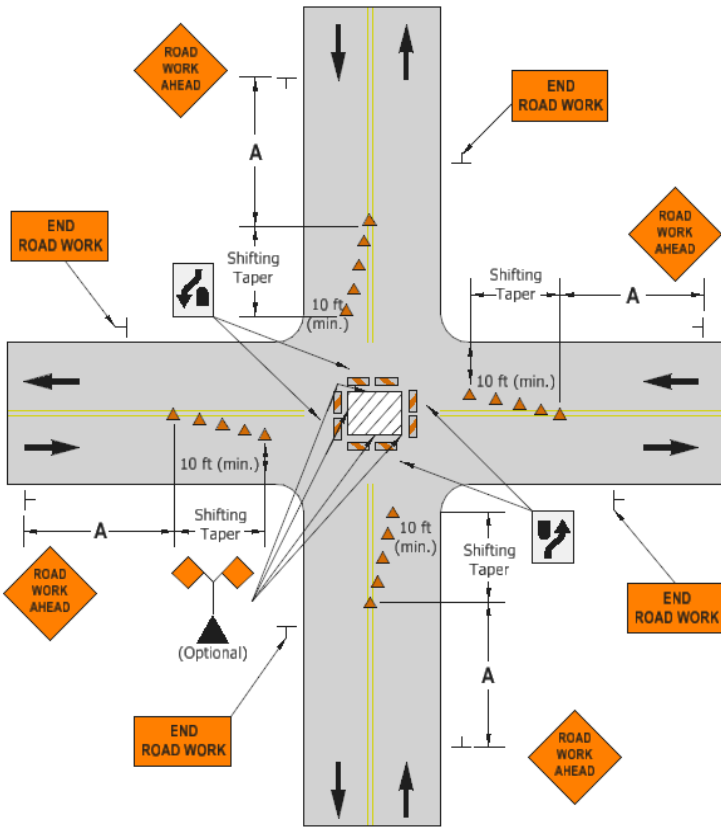

Notes:

1. Left turns may need to be prohibited.
2. See page 16 for shifting tapers.

Speed Limit (mph)	Sign Spacing A (ft.)
30	100
25	350
40	350
45	500
50	500
55	500
60	1000

Work In a Roundabout

(Short Term Stationary – 1 to 12 hours)

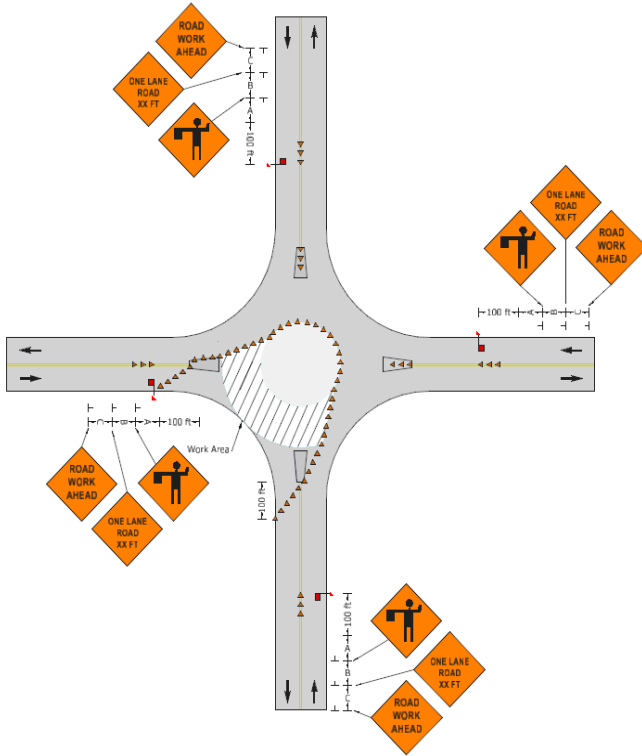

Notes:

1. The flagger shall use approved flagger procedures according to the IMUTCD and page 77.
2. Only one direction of approach traffic shall be released at a time.
3. Conflicting WRONG WAY, ONE WAY, and directional arrow signs shall be covered.
4. Work in a multilane roundabout should be restricted to one lane within the roundabout at a time to maintain normal counterclockwise traffic flow.

Speed Limit (mph)	Sign Spacing (ft.)		
	A	B	C
25	100	100	100
30	100	100	100
35	350	350	350
40	350	350	350
45	500	500	500
50	500	500	500
55	500	500	500
60	1000	1600	2640

**Short Duration
(Up to 1 hour)**

Work off the Traveled Lanes (Includes Paved Shoulder < 8ft.)

(Short Duration – up to 1 Hour)

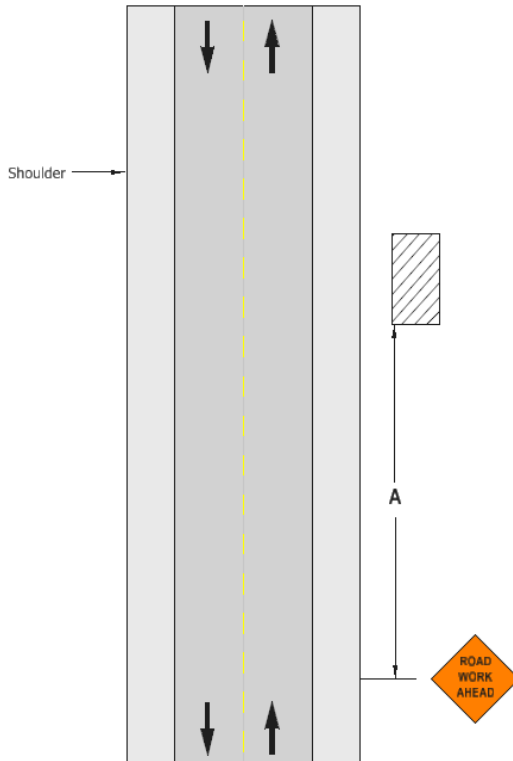

Notes:

1. Other acceptable advance warning signs are those indicating SHOULDER WORK, UTILITY WORK AHEAD, or the WORKERS sign.
2. An advance warning sign shall be used; if the work will be performed immediately adjacent to the shoulder, if equipment will cross or move along the roadway, or if the activity may distract motorists.

Speed Limit (mph)	Sign Spacing A (ft.)
25	100
30	100
35	350
40	350
45	500
50	500
55	500
60	1000

Work on Paved Shoulders or Parking Lane > 8ft.

(Short Duration – up to 1 hour)

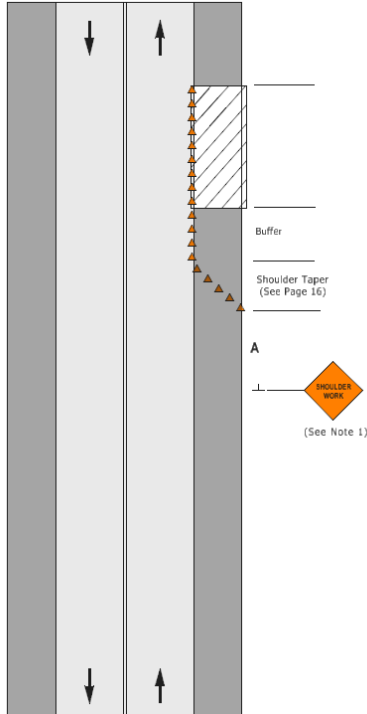

Notes:

1. Other standard IMUTCD signs may be used such as “ROAD WORK AHEAD”, “UTILITY WORK AHEAD”, or the WORKERS sign.
2. Shadow vehicle recommended inside coned area.

Speed Limit (mph)	Sign Spacing A (ft.)	Buffer (ft.)
25	100	160
30	100	200
35	350	280
40	350	320
45	500	360
50	500	440
55	500	520
60	1000	600

**Work on Paved Shoulder >8 ft.
Closed on Divided Roadway**
(Short Duration – up to 1 hour)

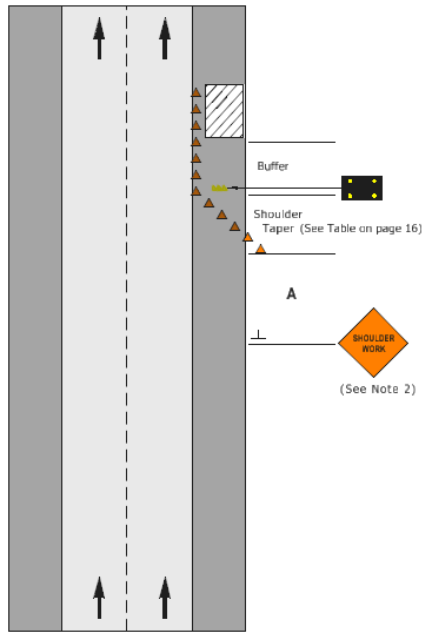

Notes:

1. The arrow display shall be operated in caution mode. Sign spacing and buffer lengths for freeways should be based on 70 mph regardless of posted speed limit.
2. Other acceptable advance warning signs are those indicating SHOULDER WORK, UTILITY WORK AHEAD, or the WORKERS sign.
3. Shadow vehicle recommended in coned area.

Speed Limit (mph)	Sign Spacing A (ft.)	Buffer (ft.)
30	100	200
35	350	280
40	350	320
45	500	360
50	1000	440
55	1000	520
60	1000	600
65	1000	680
70	1000	760

Lane Closure on Divided Roadway or One Way Street

(Short Duration – up to 1 hour)

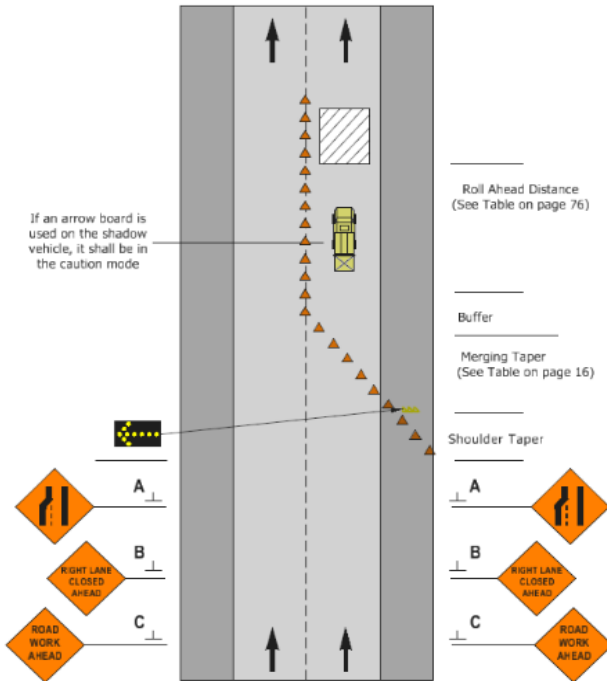

Notes:

1. When a side road intersects the roadway within the work zone, additional devices shall be erected to channelize traffic to/from the side road, and a ROAD WORK AHEAD, UTILITY WORK AHEAD, or the WORKERS sign shall be placed on each side road approach.
2. Sign spacing and buffer lengths for freeways should be based on 70 mph regardless of posted speed limit.

Speed Limit (mph)	Sign Spacing (ft.)			Buffer (ft.)
	A	B	C	
30	100	100	100	200
35	350	350	350	280
40	350	350	350	320
45	500	500	500	360
50	1000	1600	2640	440
55	1000	1600	2640	520
60	1000	1600	2640	600
65	1000	1600	2640	680
70	1000	1600	2640	760

Lane Closure on a Two-Lane Road (Two Flagger Operation) (Short Duration – up to 1 hour)

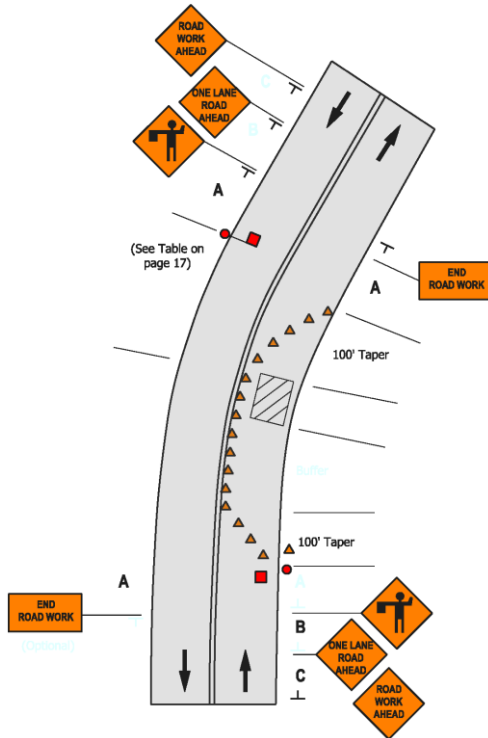

Notes:

1. The flaggers shall use approved flagging procedures according to the IMUTCD and as shown on page 77.
2. If there is a side road intersection within the work area, additional traffic control, such as flaggers and appropriate signage, shall be used on the sideroad approaches.
3. Whenever a flagger is present, a “Flagger Ahead” symbolic sign shall be used.

Speed Limit (mph)	Sign Spacings (ft.)			Buffer (ft.)
	A	B	C	
25	100	100	100	160
30	100	100	100	200
35	350	350	350	280
40	350	350	350	320
45	500	500	500	360
50	500	500	500	440
55	500	500	500	520
60	100	1600	2640	600

Temporary Road Closure

(Short Duration – up to 20 minutes)

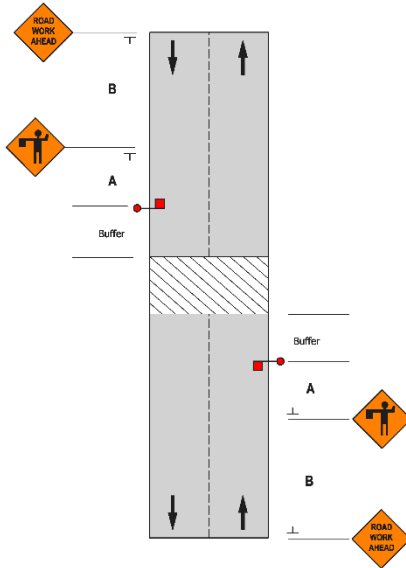

Notes:

1. Conditions represented are for work which requires closings during daytime hours only.
2. Closure periods shall be no longer than 20 minutes but may be repeated after traffic is released to accomplish the work to be done.
3. For planned work the District Communications Office and the TMC should be informed as soon as the decision is made to close the highway.
4. For high-volume two-lane roads, a police patrol car and/or a changeable message sign may be added. Two lane roads with an AADT greater than 10,000 are considered high volume.
5. For multi lane roads a police officer shall be used to control traffic, flaggers shall not be used.
6. The flagger shall stop the first vehicle from the shoulder as shown. After stopping the first vehicle if the view of the flagger is obstructed, then he/she should move to the centerline to stop additional oncoming traffic.
7. Flaggers shall use approved flagging procedures according to the IMUTCD and as shown on page 77.
8. If a closure longer than 20 minutes is needed, traffic must be completely released after 20 minutes before a second 20-minute closure is used.

Speed Limit (mph)	Sign Spacings (ft.)		Buffer (ft.)
	A	B	
25	100	100	160
30	100	100	200
35	350	350	280
40	350	350	320
45	500	500	360
50	500	500	440
55	500	500	520
60	1000	1600	600

Lane Closure in Advance of an Intersection (Work Area on the Major Road)

(Short Duration – up to 1 hour)

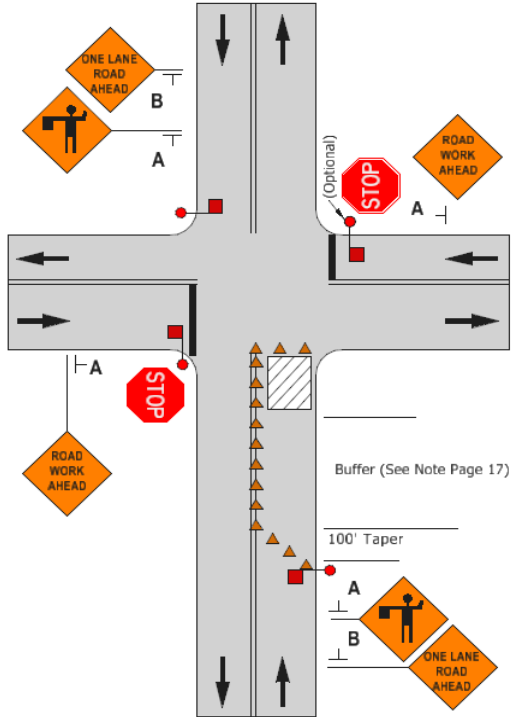

Notes:

1. The flaggers shall use approved flagging procedures according to the IMUTCD and as shown on page 77.
2. Whenever a flagger is present, a “Flagger Ahead” symbolic sign shall be used.
3. As an alternative to this method on low volume roads (AADT less than 500) or in urban areas where detour routes are readily available, the entire approach under construction may be closed.

Speed Limit (mph)	Sign Spacing (ft.)		Buffer (ft.)
	A	B	
25	100	100	160
30	100	100	200
35	350	350	280
40	350	350	320
45	500	500	360
50	500	500	440
55	500	500	520
60	1000	1600	600

Lane Closure in Advance of an Intersection (Work Area on the Minor Road)

(Short Duration – up to 1 hour)

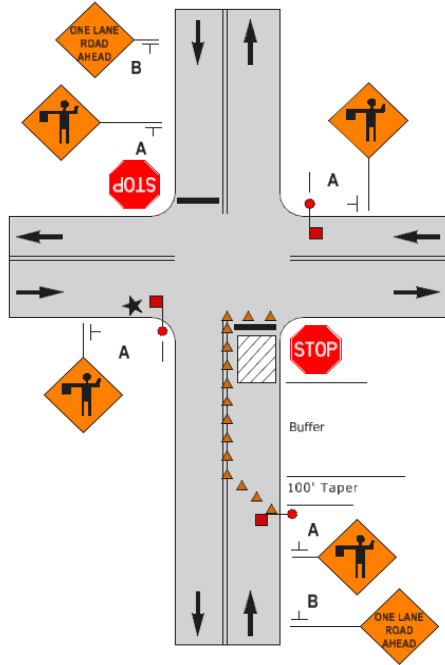

Notes:

1. Depending on traffic conditions, additional traffic control, such as flaggers and appropriate signage, may be needed.
2. The middle flagger (★) has the best view of traffic from all directions. This flagger should be designated **lead flagger** and should coordinate the actions of the other flaggers.
3. **The flaggers shall use approved flagging procedures according to the IMUTCD and as shown on page 77.**
4. As an alternative to this method on low volume roads (AADT less than 500) or in urban areas where detour routes are readily available, the entire approach under construction may be closed.

Speed Limit (mph)	Sign Spacing (ft.)		Buffer (ft.)
	A	B	
25	100	100	160
30	100	100	200
35	350	350	280
40	350	350	320
45	500	500	360
50	500	500	440
55	500	500	520
60	1000	1600	600

Lane Closure Beyond an Intersection (Work Area on the Major Road)

(Short Duration – up to 1 hour)

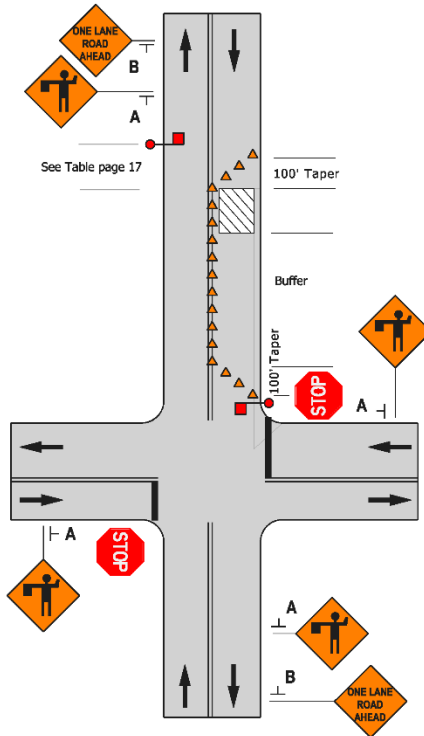

Notes:

1. Depending on traffic conditions, additional traffic control, such as flaggers and appropriate signage, may be needed.
2. The flaggers shall use approved flagging procedures according to the IMUTCD and as shown on page 77.
3. When there is insufficient space the Two-Way Traffic taper may be reduced to 50 ft and the remaining space used for the buffer.
4. When possible, the side road (both approaches) should be closed.
5. A shadow vehicle must be used if there is adequate space, including taper and buffer, between the work area and the intersection.

Speed Limit (mph)	Sign Spacing (ft.)		Buffer (ft.)
	A	B	
25	100	100	160
30	100	100	200
35	350	350	280
40	350	350	320
45	500	500	360
50	500	500	440
55	500	500	520
60	1000	1600	600

Lane Closure Beyond an Intersection (Work Area on the Minor Road)

(Short Duration – up to 1 hour)

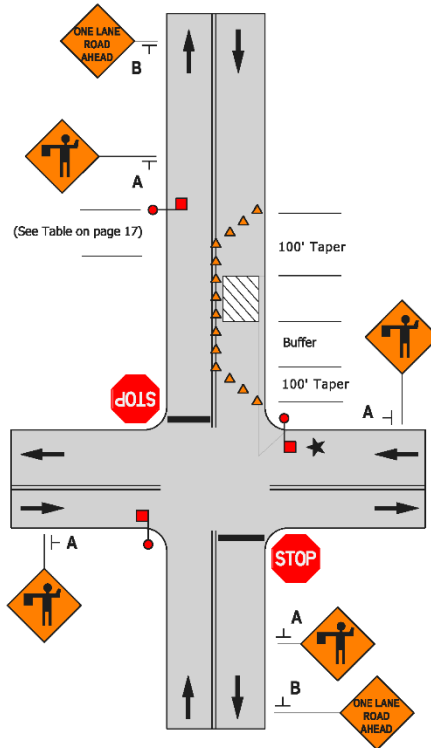

Notes:

1. Depending on traffic conditions, additional traffic control, such as flaggers and appropriate signage, may be needed.
2. The middle flagger (★) is the **lead flagger** and shall coordinate the actions of the other flaggers.
3. **The flaggers shall use approved flagging procedures according to the IMUTCD and as shown on page 77.**
4. When there is insufficient space the Two-Way Traffic taper may be reduced to 50 feet and the remaining space used for the buffer.
5. A shadow vehicle must be used if there is adequate space, including taper and buffer, between the work area and the intersection.

Speed Limit (mph)	Sign Spacing (ft.)		Buffer (ft.)
	A	B	
25	100	100	160
30	100	100	200
35	350	350	280
40	350	350	320
45	500	500	360
50	500	500	440
55	500	500	520
60	1000	1600	600

Lane Closure at Side of Intersection

(Short Duration – up to 1 hour)

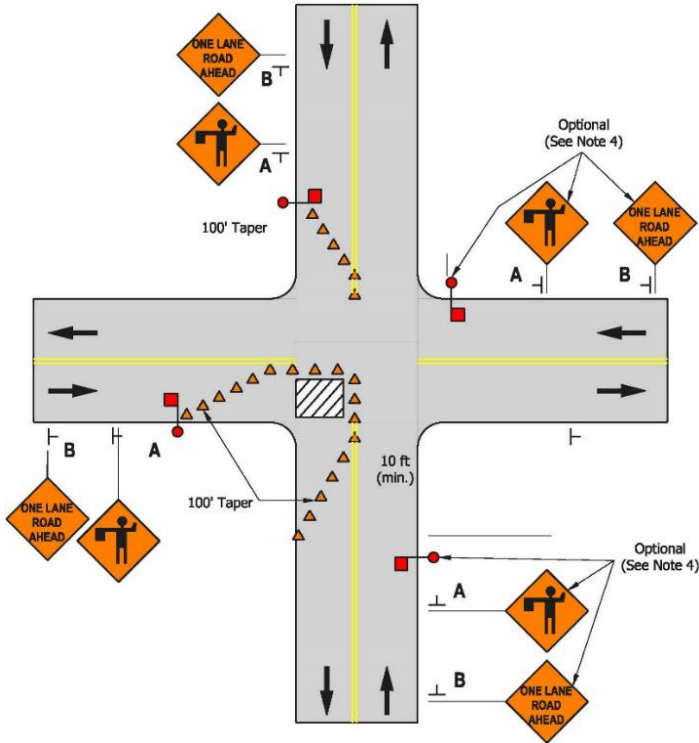

Notes:

1. For high traffic volumes or when a four-lane street is involved, additional flaggers or law enforcement personnel may be used.
2. The situation depicted can be simplified by closing one of more of the intersection approaches. If this cannot be done and/or when capacity is a problem consideration should be given to diverting through traffic to other roads or streets or performing the work at night or during other off-peak hours.
3. Flashing warning lights and/or flags may be used to call attention to the advanced warning signs.
4. Flaggers and signs for these approaches are optional. If the length of the closure and/or traffic warrant these flaggers with warning sign should be used.

Speed Limit (mph)	Sign Spacing (ft.)		Buffer (ft.)
	A	B	
25	100	100	160
30	100	100	200
35	350	350	280
40	350	350	320
45	500	500	360
50	500	500	440
55	500	500	520
60	1000	1600	600

Work in Center of Intersection

(Short Duration – up to 1 hour)

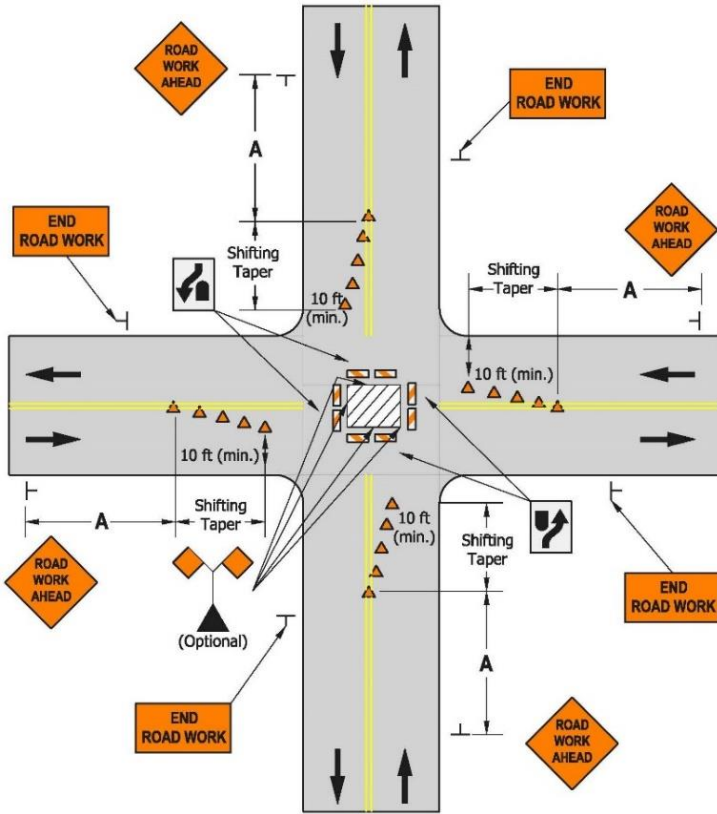

Notes:

1. Left turns may need to be prohibited.
2. A high-level warning device may be placed in the workspace if there is sufficient room.
3. When the width of the intersection will not accommodate the work area and traffic to be maintained on either side, consideration should be given to closing the intersection.

Speed Limit (mph)	Sign Spacing (ft.)
30	100
35	350
40	350
45	500
50	500
55	500
60	1000

Lane Closure at a Multilane Intersection (Short Duration – up to 1 hour)

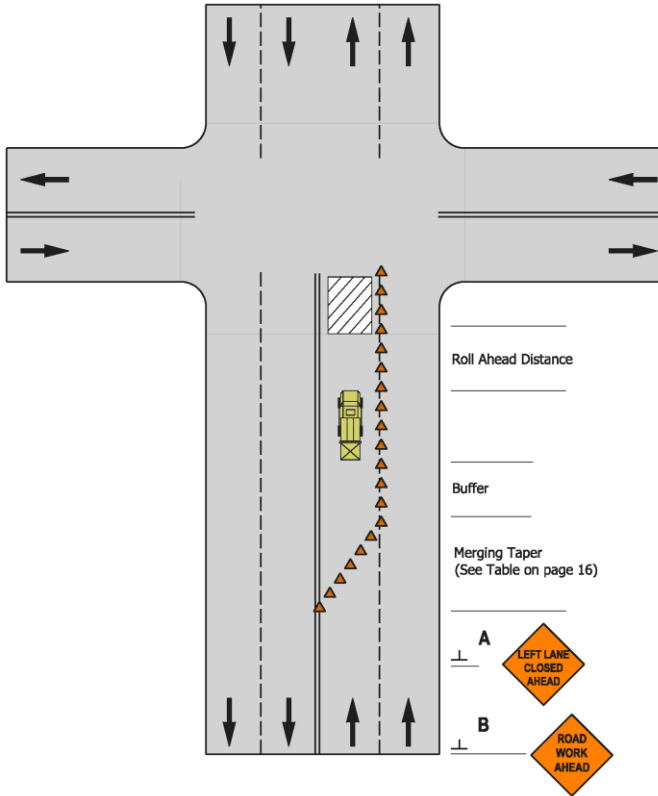

Notes:

1. The length of tapers may be adjusted when used in close proximity to crossroads, curves, or other influencing factors.
2. Arrow board is recommended if AADT are greater than 30,000. It is optional for other highways.
3. If working on far side of intersection, see page 63.

Speed Limit (mph)	Sign Spacing (ft.)		Buffer (ft.)	Roll-ahead Distance	
	A	B		Stationary	Mobile
25	100	100	160	100	150
30	100	100	200	100	150
35	350	350	280	100	150
40	350	350	320	100	150
45	500	500	360	100	150
50	500	500	440	150	200
55	500	500	520	150	200
60	1000	1600	600	200	275

Turn Lane Closure at an Intersection

(Short Duration – up to 1 hour)

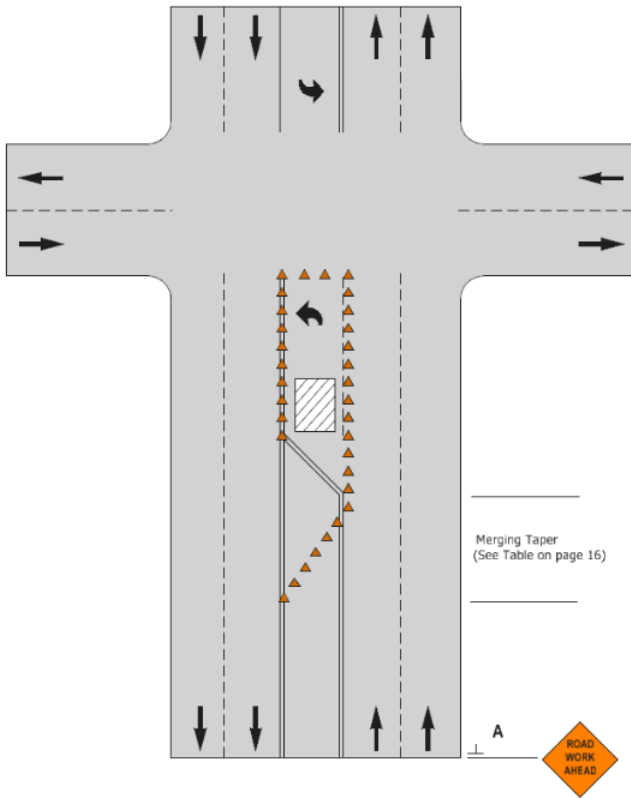

Notes:

1. Lane may be opened beyond work area.
2. The length of the tapers may be adjusted when used in close proximity to crossroads, curves, or other influencing factors.

Speed Limit (mph)	Sign Spacing A (ft.)
25	100
30	100
35	350
40	350
45	500
50	500
55	500
60	1000

Partial Ramp Closure *(Short Duration – up to 1 hour)*

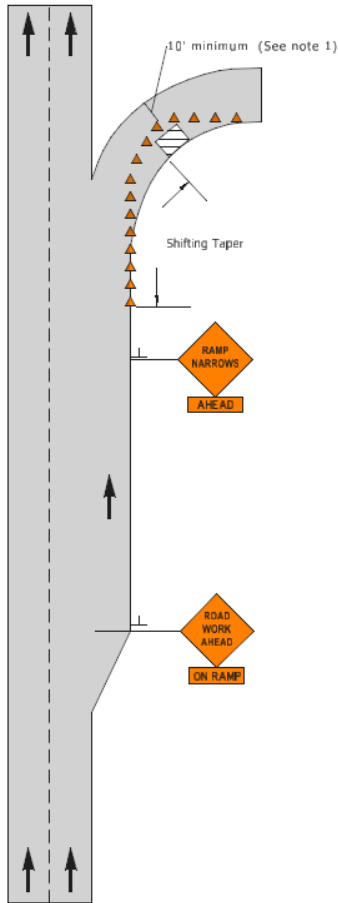

Notes:

1. Truck off-tracking should be considered when determining whether the 10' minimum lane width is adequate.
2. For work on the outside of the ramp, the cones will be shifted to that side, and the gore area extended upstream.

Partial Ramp Closure Work in Gore Area

(Short Duration – up to 1 hour)

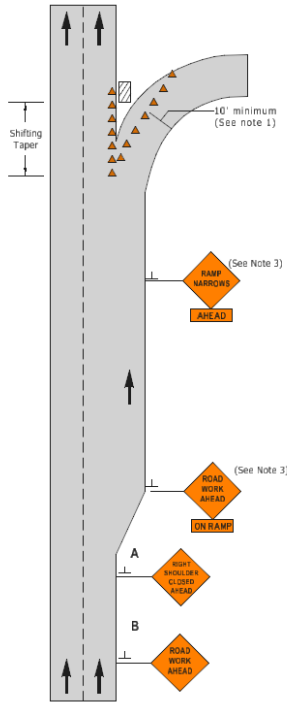

Notes:

1. Truck off-tracking should be considered when determining whether the 10-foot minimum lane width is adequate.
2. Shadow vehicle recommended inside coned area if roll-ahead distance permits.
3. Required if coned area or work area extends into the ramp.

Speed Limit (mph)	Sign Spacing (ft.)	
	A	B
25	100	100
30	100	100
35	350	350
40	350	350
45	500	500
50	1000	1600
55	1000	1600
60	1000	1600
65	1000	1600
70	1000	1600

Mobile Operations

Mobile Operations

Mobile operations are work activities that move along the road either intermittently or continuously. Safety for mobile operations should not be compromised by using fewer devices simply because the operation will frequently change its location.

Portable devices should be used. For example, appropriately colored and marked vehicles with vehicle warning lights, perhaps augmented with signs or arrow displays, may be used in place of signs and channelizing devices.

For successful mobile operations, the advance warning area for these operations must move with the work area or be repositioned periodically to provide advanced warning for the motorist.

Truck or trailer mounted attenuators must be deployed as they were crash tested. Temporary signs cannot be mounted on them.

Intermittent Mobile Operations – These mobile operations often involve frequent short stops that are similar to stationary operations. Flashing vehicle lights shall be used and warning signs shall be used as shown in the diagrams.

With operations that move slowly (less than 3 mph), it may be feasible to use stationary signing that is periodically retrieved and repositioned in the advance warning area. Vehicles may additionally be equipped with such devices as vehicle warning lights, truck mounted attenuators, and appropriate signs.

Flaggers may be used on two-lane highways, but caution must be exercised so flaggers are not exposed to unnecessary hazards.

Continuously Moving Mobile Operations – These mobile operations include work activities in which workers and equipment move along the road without stopping, usually at slow speeds. These activities may include pavement striping, mowing, street sweeping, or herbicide spraying.

A shadow vehicle, equipped as a sign truck, should follow the work vehicle. The advance warning area moves with the work area. If a lead vehicle is utilized, then an END CONSTRUCTION or END ROAD WORK sign should be used to help identify the end of the work zone.

***Mobile Operation on Paved Shoulder
>8ft. for all Roads***

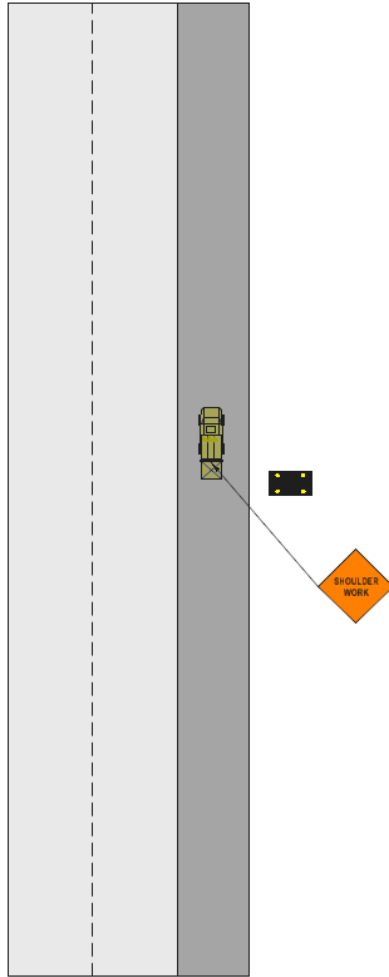

Mobile Operation on the Shoulder (cont.)

Notes:

1. If the operation requires encroachment on the travel way, a mobile or stationary lane closure should be used.
2. For operations that move slowly (less than 3 mph) and in situations where multiple work locations in a limited distance make it practical to place stationary signs, the maximum spacing from the advanced warning sign to the beginning of the work is 5 miles.
3. The length of work sign or a supplemental panel (Next XX Miles) may be used for work zones of more than 2 miles in length.
4. If the distance between work locations is 1 mile or more, and if the work vehicle travels at traffic speeds between locations, warning signs are not required if vehicle warning lights are used.
5. Other acceptable advanced warning signs include SHOULDER WORK, UTILITY WORK AHEAD, MOWING, WORKER SIGNS, and ROAD MACHINERY AHEAD.
6. Arrow board shall be in caution mode.
7. The table below shows recommended roll-ahead distances between a shadow vehicle and the work area for both stationary and mobile operations. Roll-ahead distances listed are for in-house maintenance work only. For contracted work, the truck or trailer mounted attenuator manufacturer's recommendations should be followed.

Roll-ahead Distances		
Speed	Stationary	Mobile
< 45 mph	100 ft.	150 ft.
50-55 mph	150 ft.	200 ft.
60-65 mph	200 ft.	275 ft.
70 mph	225 ft.	325 ft.

Mobile Operation on a Two-Lane, Two-Way Road

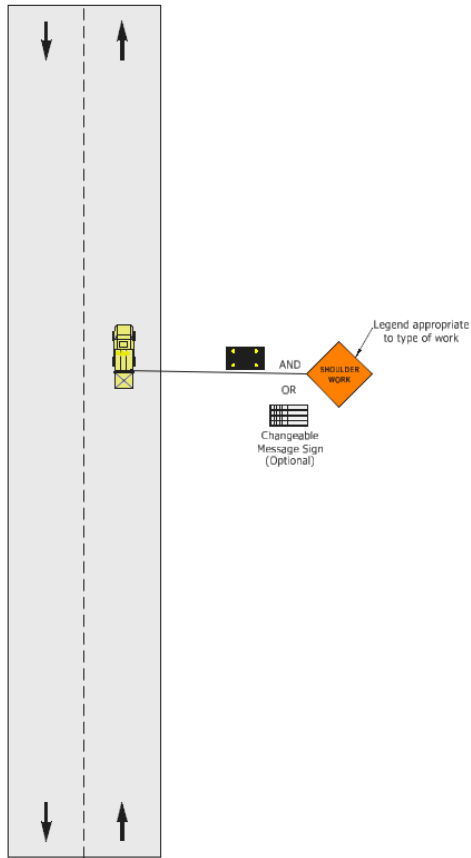

Roll-ahead Distances

Speed	Stationary	Mobile
< 45 mph	100 ft.	150 ft.
50-55 mph	150 ft.	200 ft.
60-65 mph	200 ft.	275 ft.
70 mph	225 ft.	325 ft.

Mobile Operation on a Two-Lane, Two-Way Road (cont.)

Notes:

1. Where practicable and when needed, the work and shadow vehicles should pull over periodically to allow traffic to pass. If this cannot be done frequently, as an alternative, a DO NOT PASS sign may be placed on the rear of the vehicle blocking the lane.
2. Flaggers may be used. If flaggers are used, then a “Flagger Ahead” **symbolic sign** and a ONE LANE ROAD AHEAD sign shall be used in each direction. If flaggers are used for more than 1 hour, then a ROAD WORK AHEAD sign shall be used as well. Refer to page 17 for flagger placement.
3. The distance between the work and shadow vehicle may vary according to terrain, paint drying time, and other factors. Shadow vehicles are used to warn traffic of the operation ahead. Whenever adequate stopping sight distance exists to the rear, the shadow vehicle should maintain the minimum roll-ahead distance and proceed at the same speed as the work vehicle. The shadow vehicle should slow down in advance of vertical or horizontal curves that restrict sight distance.
4. Sign legends shall be covered or turned from view when work is not in progress.
5. Arrow board shall be in caution mode.

Mobile Operation on a Two-Lane Road Using Flaggers

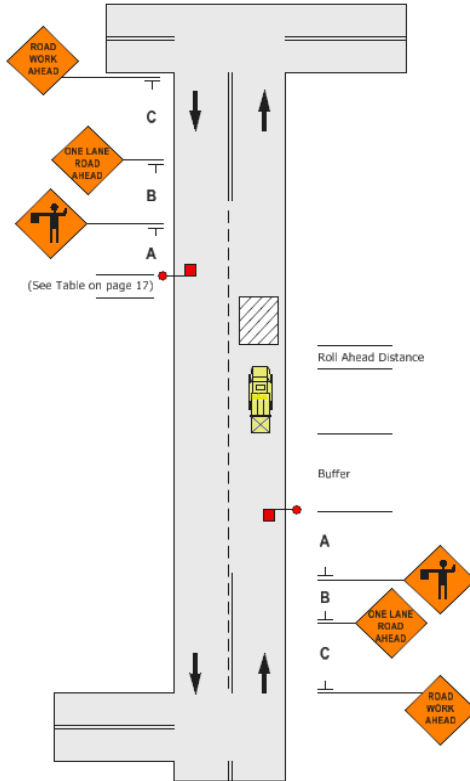

Notes:

1. Additional flagger ahead signs may be staged for work over 5 miles in length but shall be turned away from all traffic or laid down until needed.
2. Arrow board shall be in caution mode.
3. For mobile operations, sign C may be a maximum of 5 miles in advance of the shadow vehicle.

Speed Limit (mph)	Minimum Sign Spacing (ft.)			Buffer (ft.)	Roll-ahead Distances	
	A	B	C		Stationary	Mobile
25	100	100	100	160	100	150
30	100	100	100	200	100	150
35	350	350	350	280	100	150
40	350	350	350	320	100	150
45	500	500	500	360	100	150
50	500	500	500	440	150	200
55	500	500	500	520	150	200
60	1000	1600	2640	600	200	275

Mobile Operation on a Four-Lane Divided Road

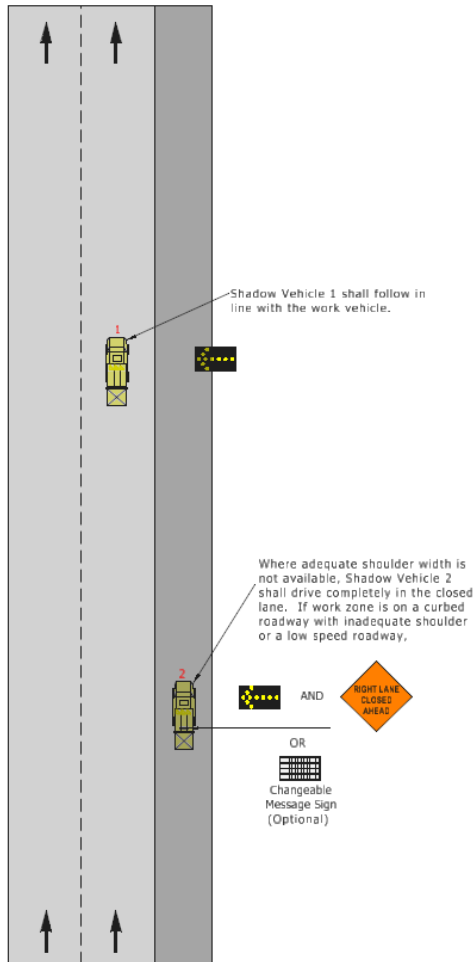

Notes:

1. See notes #2 and #4 on page 70.

Mobile Operation on a Multi-Lane Divided Road

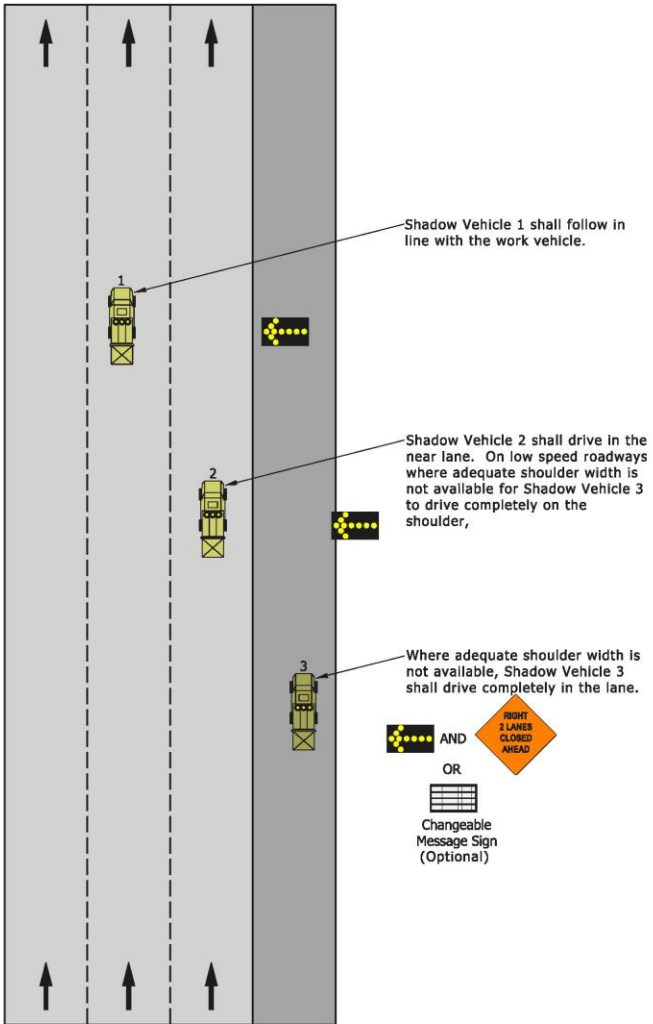

Mobile Operation on a Multi-Lane Road (cont.)

Notes:

1. Shadow vehicle #3 should travel at a varying distance from the work operation so as to provide adequate sight distance for traffic approaching from the rear.
2. For operations that move slowly (less than 3 mph) and in situations where multiple work locations in a limited distance make it practical to place stationary signs, the maximum spacing from the advanced warning sign to the beginning of the work is 5 miles.
3. Stationary advance warning signs may be used to provide additional advance warning for the operation. These signs might include SLOW MOVING TRAFFIC AHEAD, ROAD WORK AHEAD, PAINT CREW AHEAD, etc. These signs and/or a changeable message sign should be used where speeds and volumes are high, or where sight distance is limited. If used, these signs shall be spaced a maximum of 5 miles from shadow vehicle #3.
4. If stationary signs are used and the activity is spread out over a distance of more than 2 miles, the length of work sign or a supplemental panel should be used.
5. Work should normally be done during off-peak hours.
6. Shadow Vehicle (SV) spacing:
 - Between Work Vehicle and nearest SV, refer to roll ahead table below.
 - Approximately 500' between middle SVs
 - 1000' - 2000' between SV#2 and SV#3. Urban roadways may require shorter distances.
 - Exact spacing will be determined by the crew leader.
7. In an urban, non-interstate area, the number of shadow vehicles may be reduced.
8. When the shoulder does not have adequate width for a shadow vehicle to get completely off the roadway, then shadow vehicle #3 is optional.
9. Roll-ahead distance for interstates and freeways should be based on 70 mph.

Roll-ahead Distances

Speed	Stationary	Mobile
< 45 mph	100 ft.	150 ft.
50-55 mph	150 ft.	200 ft.
60-65 mph	200 ft.	275 ft.
70 mph	225 ft.	325 ft.

Flagging Procedures

Flagging shall not be used on freeways and other multilane highways except in emergency situations.

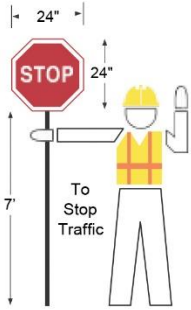

Properly Trained Flaggers

- Give clear messages to drivers as shown
- Allow time and distance for drivers to react
- Coordinate with other flaggers

Properly Equipped Flaggers

- Approved sign paddles
- Paddles are not to be used in a signalized intersection
- Approved Personal Protective Garments (PPE)
- Brightly colored hat for better visibility
- Retroreflective night equipment



Proper Flagging Stations

- Good approach sight distance
- Highly visible to traffic
- Never stand in moving traffic lane
- Always have an escape route, keep 100 feet or 2.5 skip spacing from any vehicle



Proper Advance Warning Signs

- Always use warning signs
- Allow reaction distance from signs
- Remove signs if not flagging

Flags shall only be used in emergency situations or when a paddle would present a conflicting message to the motorist. Flags shall be a minimum of 24" x 24", red in color and mounted on a staff about 3 feet long.

Quick Reference Guide

Table I: Sign Spacing (ft.)					
	25-30 mph	35-40 mph	45-55 mph	Multilane Divided 50 mph or higher	Expressway/Freeway
A	100	350	500	1000	1000
B	100	350	500	1600	1600
C	100	350	500	2640	2640

Distances shown are approximate. Sign spacing should be adjusted for intersections, curves, hills, driveways, etc., to improve sign visibility.

INDOT channelizing device (cones, drums, etc.) spacing for straight-a-ways:

- 20 to 40 mph: 1 cone for every 40 feet (every skip)
- 40 to 55 mph: 1 cone for every 80 feet (every other skip)
- 60 mph & above: 1 cone for every 120 feet (every 3 skips)

Maximum channelizing device spacing for tapers should be the distance in feet equal to the speed limit in mph.

Quick Reference Guide (cont.)

TABLE II: INDOT SKIPS BASED STANDARD TAPERS (12 Ft Closure)										
Speed (mph)	Merging Tapers			Shifting Tapers			Shoulder Tapers			
	#Skips (Length)	Cone Spacing	#Cones	#Skips (Length)	Cone Spacing	#Cones	#Skips (Length)	Cone Spacing	#Cones	
Low Speed	20	4 (160')	20	9	2 (80')	20	5	2 (80')	20	5
	25	4 (160')	20	9	2 (80')	20	5	2 (80')	20	5
	30	5 (200')	20	11	3 (120')	20	7	2 (80')	20	5
	35	7 (280')	20	15	4 (160')	20	9	3 (120')	20	7
	40	8 (320')	40	9	4 (160')	40	5	3 (120')	40	4
High Speed	45	14 (560')	40	16	7 (280')	40	8	5 (200')	40	6
	50	15 (600')	40	17	8 (320')	40	9	5 (200')	40	6
	55	17 (680')	40	18	9 (360')	40	10	6 (240')	40	7
	60	18 (720')	60	13	9 (360')	60	7	6 (240')	60	5
	65	20 (800')	60	15	10 (400')	60	8	7 (280')	60	6
	70	21 (840')	60	15	11 (440')	60	9	7 (280')	60	6

2-Way & Downstream Tapers are always 3 skips (120'), 20' cone spacing, with 7 cones

Guidelines for Buffer Lengths and Distance of Flagger Station in Advance of the Workspace (Page 16)			
Speed (mph)	MUTCD Based Buffer Length (ft)	Skips Based	
		Buffer Length (ft)	Number of Skips
20	115	120	3
25	155	160	4
30	200	200	5
35	250	280	7
40	305	320	8
45	360	360	9
50	425	440	11
55	495	520	13
60	570	600	15
65	645	680	17
70	730	760	19

Acceptable Channelizing Device Usage

(Adapted from Standard Drawing 801-TCDV-04)

Channelizing Device Type	Usage Application							
	To delineate merge tapers on		To delineate tangents where adequate space exists and also lane shift tapers on		Where the effective lane width is less than 10 ft to delineate tangents in lieu of drums on		Where the effective lane width is less than 10 ft to delineate edge of pavement drop-off in lieu of drums on	
	Freeways	Non-Freeways	Freeways	Non-Freeways	Freeways	Non-Freeways	Freeways	Non-Freeways
18 in. Cone ¹ ≤ 40 mph posted speed limit	No	Yes ⁴	No	Yes ⁴	No	No	No	No
18 in. Cone ≥ 45 mph posted speed limit	No	No	No	No	No	No	No	No
28 in. Cone ¹ ≤ 40 mph posted speed limit	No	Yes ⁵	No	Yes ⁵	No	No	No	No
28 in. Cone ² 45 mph posted speed limit	No	Yes ⁴	No	Yes ⁴	No	No	No	No
28 in. Cone ≥ 50 mph posted speed limit	No	Yes ⁴	No	Yes ⁴	No	No	No	No
42 in. Channelizer ^{1,6} ≤ 45 mph posted speed limit	No	Yes ⁵	No	Yes ⁵	Yes	Yes	Yes	Yes
42 in. Channelizer ^{2,6} ≥ 50 mph posted speed limit	No	Yes ⁵	No	Yes ⁵	Yes	Yes	Yes	Yes

Acceptable Channelizing Device Usage (cont.)

Notes:

1. Spacing in tangent shall be 40 feet maximum; spacing between devices in taper shall be numerically equal in feet, maximum, to the posted speed limit in mph.
2. Spacing in tangent shall be 80 feet maximum; spacing between devices in taper shall be numerically equal in feet, maximum, to the posted speed limit in mph.
3. Spacing in tangents shall be 50 feet maximum when the speed limit is 45 mph or below; spacing in tangents shall be 100 feet maximum when the posted speed limit is 50 mph or above; in cases where the posted speed limit is intermittently set to 45 mph the channelizing devices shall be maintained at 90 feet maximum spacing; spacing of channelizing devices on tapers shall be numerically equal in feet, maximum, to the posted speed limit in mph.
4. May only be used for daylight restrictions.
5. May not be used for long-term, stationary work (more than 3 days).
6. 30 lbs. ballast configuration required.
7. For the purpose of channelizing device usage and spacing, the posted speed limit is the permanent posted speed limit, temporary speed limit, or worksite speed limit, whichever is lower.



Indiana Department of Transportation
100 North Senate Avenue, Room N758
Indianapolis, IN 46204
www.in.gov/indot



INDOT Customer Service:
855-463-6848
INDOT4U.com
INDOT@indot.in.gov



<https://www.in.gov/indot/safety/work-zone-safety/>